



JOINT INSTITUTE FOR NUCLEAR RESEARCH  
Frank Laboratory of Neutron Physics

## **FINAL REPORT ON THE START PROGRAMME**

*Automation of the system for the  
production of mesitylene balls of a  
cryogenic moderator*

**Supervisor:**

Dr. Maksim Viktorovich  
Bulavin

**Student:**

Ivan Litvak, LPR  
Luhansk State University  
named after V. Dahl

**Participation period:**

August 21 – October 08,  
Summer Session 2022

Dubna, 2022

## Abstract

The development and implementation of cold neutron sources is a complex and multifaceted work that requires both extensive theoretical research and a large number of experiments in various fields of physics. This report discusses the creation of more productive and unique installations for the production of solid dispersed material based on the experience of operating cryogenic moderators in the IBR-2. The main criteria are: a high flux of cold neutrons, a small temperature gradient of the thermalizing agent, the safety of the cryogenic moderator (and, as a result, the reactor), and the complexity of use and production. The mixture of mesitylene and m-xylene has the best safety record and is relatively easy to manufacture and operate, while having high thermalization and neutron yield. Methane, on the other hand, is more demanding on operating conditions and is difficult to manufacture, but it allows obtaining the best neutron flux and thermalization.

## Introduction

At present, the only source of cold neutrons based on mesitylene and m-xylene is the complex of cryogenic moderators at the IBR-2 reactor. There are more than 15 sources of cold neutrons operating in the world [1]. New neutron sources are being built, which also require efficient and safe cryogenic moderators: European Spallation Source (ESS, Lund, Sweden), HANARO (Tajon, South Korea) [2], PIK reactor (Gatchina, Russia) [3]. IR-8 is being modernized in Moscow (National Research Center "Kurchatov Institute") [4] and new sources are being developed: DARIA (compact neutron sources based on new technologies of linear accelerators) [5] and the future IBR-3 reactor (Neptune) [6], for which will require from 5 liters of the working substance daily.

Long-term research and operation of cold moderators at neutron sources of different intensity around the world make it possible to identify the following materials that are used as a working substance for neutron moderation: hydrogen in the liquid phase (also mixed with deuterium or pure deuterium), methane in the liquid and solid phases [7], mesitylene in the solid phase [7, 8]. The most technologically advanced and most commonly used material for cold moderators today is liquid hydrogen [9].

All this indicates the need to develop both the moderators themselves and the technologies for the production of the working substance, which can satisfy the growing demand for volumes and quality, and will also ensure the safe operation of the sources.

# 1. Advantages of Mesitylene-m-xylene beads compared to other moderator materials

Mesitylene has a high radiation resistance compared to methane or ice. The yield of hydrogen from mesitylene as a result of interaction with a neutron flux is 10 times less than from methane, and from its mixture with toluene or m-xylene, even 20 times less [1, 8]. This is extremely important for pulsed reactors, which are ten times more sensitive to changes in geometry (which can occur from a hydrogen explosion) compared to stationary reactors.

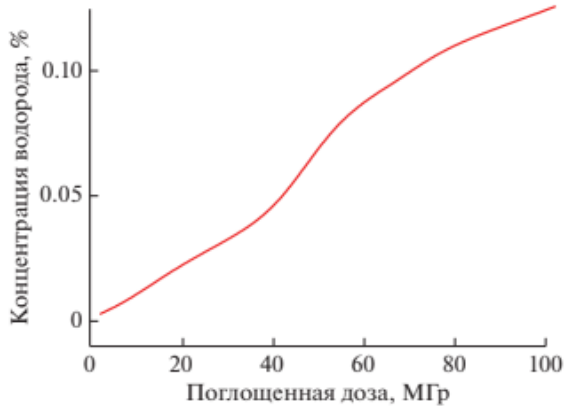

**Fig. 1.** Dependence of the concentration of radiolytic hydrogen on the absorbed dose at a working mixture temperature of ~25 K.

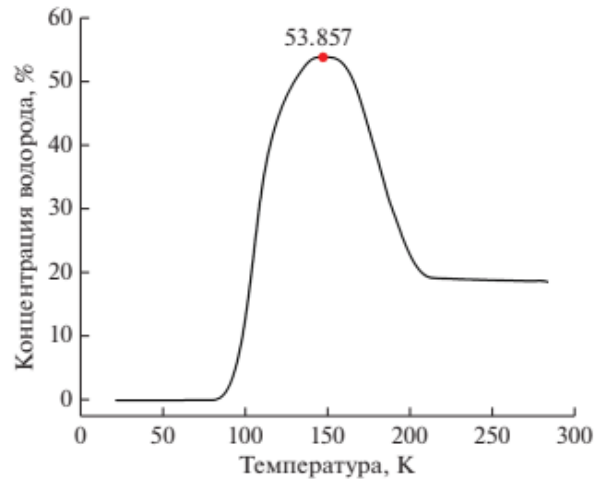
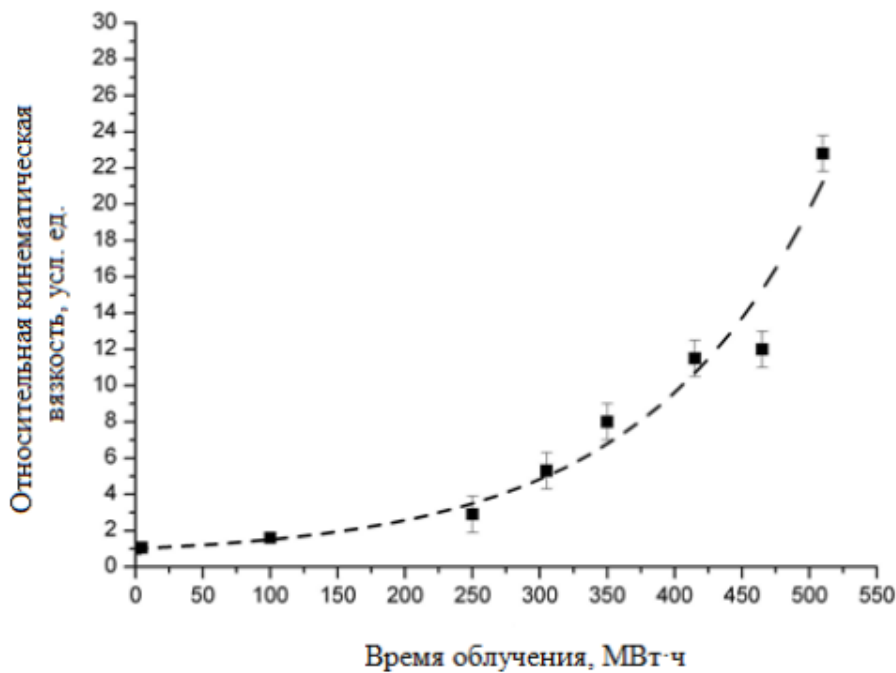

**Fig. 2.** Dependence of the concentration of radiolytic hydrogen on temperature during post-radiation heating of the irradiated working mixture. Warm-up time approx. 17 h.

In contrast to methane and ice, mesitylene practically does not accumulate radicals; therefore, “spontaneous” temperature bursts (radical recombination reactions) are not observed. The operation of a set of moderators based on solid mesitylene balls at the IBR-2 reactor [8] did not reveal radiation polymerization of mesitylene under the action of irradiation.

**Table 1.** The composition of the mixture of mesitylene and metaxylene before and after irradiation with a dose of 100 MGy [1]

Name	Concentration before irradiation, wt. %	Concentration after irradiation, wt. %
Mesitylene (1, 3, 5-trimethylbenzene)	82,6	0
M-Xylene (1,3-dimethylbenzene)	16,7	0
Pseudocumene (1, 2, 4-trimethylbenzene)	0,45	35
3-Ethyltoluene (1-methyl-3-ethylbenzene)	0,25	0
Paraxylene (1,4-dimethylbenzene)	0	15
Miscellaneous, including unidentified chemicals	0	50

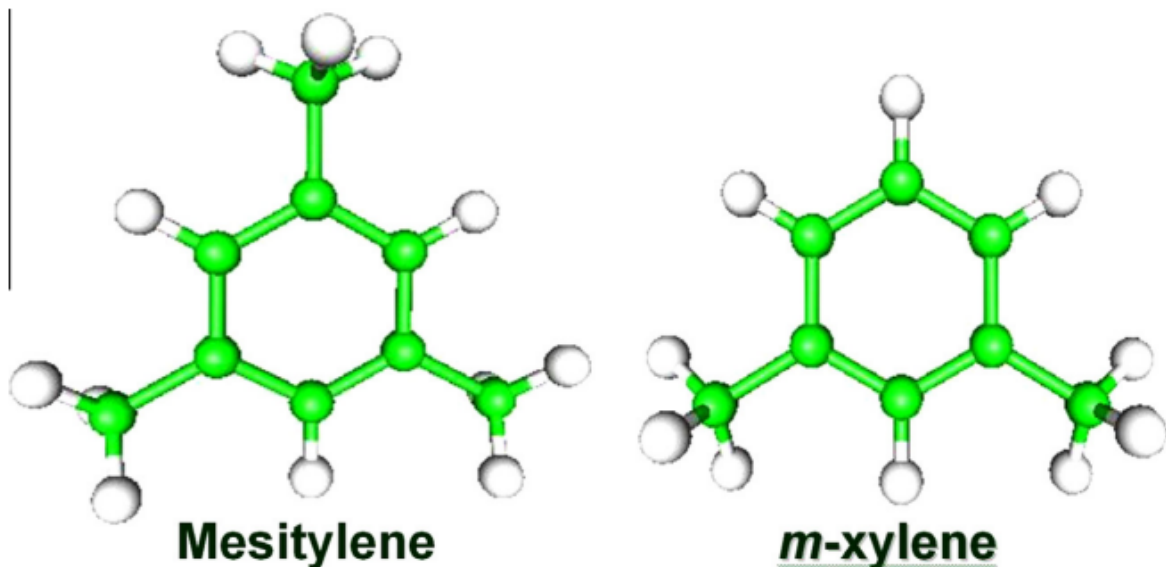

**Fig. 3.** The viscosity of the irradiated mixture of mesitylene and m-xylene depending on the exposure time



**Fig. 4.** Molten irradiated mixture of mesitylene and m-xylene

The presence of low energy levels of molecules in mesitylene promotes rapid thermalization of neutrons. The mesitylene molecule contains three CH<sub>3</sub> complexes, which perform a slightly hindered rotation around the symmetry axis of the complex [10]. The energy of such rotations for solid mesitylene is 7 meV, and for its mixtures with various benzene derivatives, which are characterized by the “proton glass” structure [11] – 5 meV.



**Fig. 5.** Mesitylene and m-xylene molecular structure. Green color marks carbon atoms, whites are hydrogen atoms

Measurements of the spectra of cold neutrons and experimental data on the cross sections of inelastic scattering indicate that mesitylene gives a significantly higher yield of cold neutrons, in comparison with ice, better than liquid hydrogen, but loses to solid methane

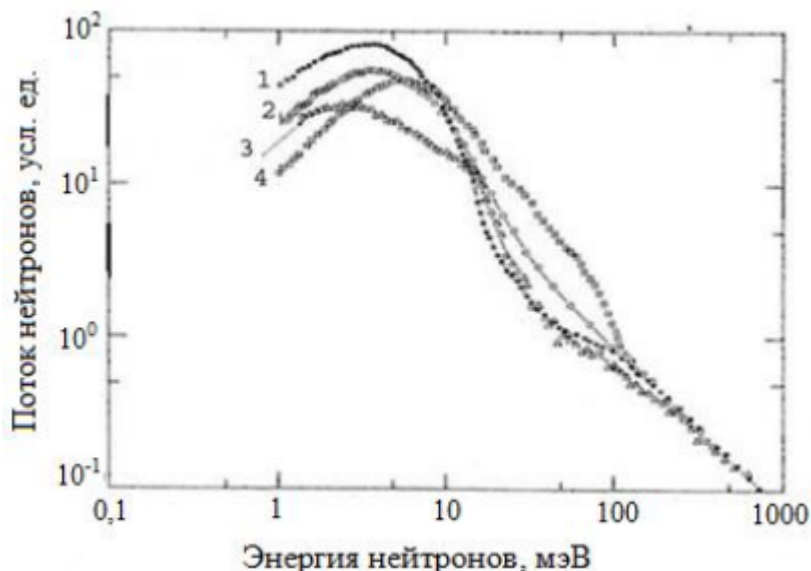

**Fig. 6.** Neutron spectrum after passing through various materials: 1 – methane ( $\text{CH}_4$ ),  $T = 31 \text{ K}$ ; 2 – mesitylene ( $\text{C}_6\text{H}_3(\text{CH}_3)_3$ ),  $T = 25 \text{ K}$ ; 3 – liquid hydrogen ( $\text{H}_2$ ),  $T = 18 \text{ K}$ ; 4 – Water ice ( $\text{H}_2\text{O}$ ),  $T = 30 \text{ K}$  [12]

## 2. Complex of ball cryogenic moderators at the IBR-2 reactor

The IBR-2 nuclear facility is a pulsed reactor with a compact core. To ensure the conduct of scientific research, 13 channels were built around the zone for the extraction of neutrons and gamma rays. The reactor is surrounded by two biological protection walls, between which there is an annular corridor used to accommodate engineering and scientific equipment [13]. Since 2018, the average power of the IBR-2 reactor, which is 1.85 MW, has gradually decreased, reaching 1.55 MW by now [14].

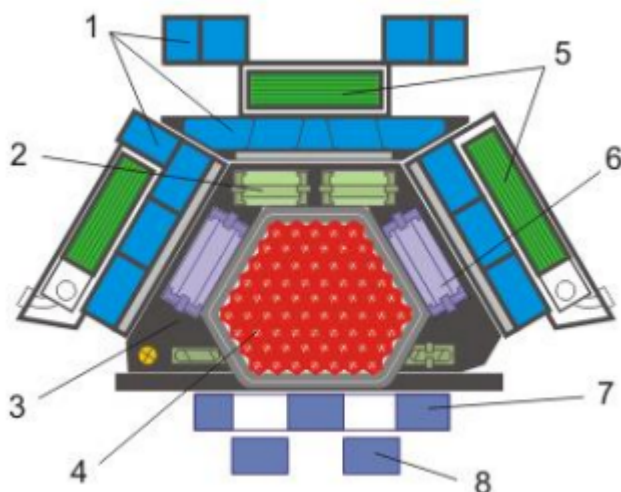

**Fig. 7.** IBR-2 reactor core: 1 - water moderators, 2 - emergency protection system, 3 - stationary reflector, 4 - fuel assemblies, 5 - cold moderators, 6 - control rods, 7 - main movable reflector, 8 - additional movable reflector

Due to the different location of CS201 and CS201 relative to the IBR-2 core, the dose load in the moderator chambers is distributed differently. The maximum calculated dose rate of neutrons and gamma rays is found in the CS201 moderator chamber and reaches 49.6 and 16.4 Gy/s, respectively (1 MW of the IBR-2 reactor power corresponds to a neutron flux of  $0.93 \times 10^{17} \text{ n/s}$ ). For one cycle of work (11 days), mesitylene balls receive the maximum total absorbed dose of  $\sim 100 \text{ MGy}$  [1, 15].

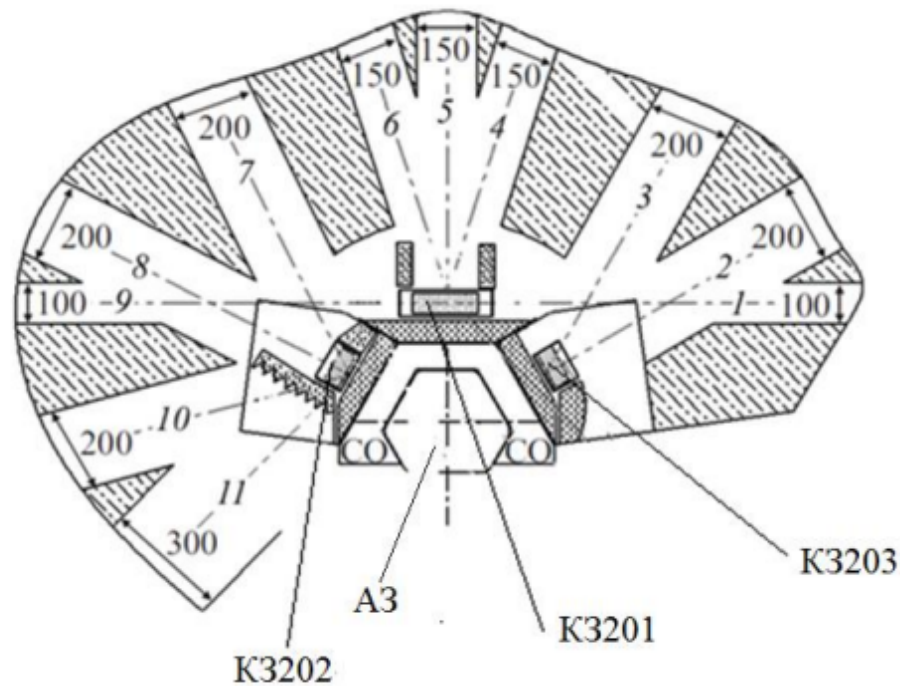

**Pic. 8.** Complex of moderators of the modernized IBR-2 reactor. K3201 - cold moderator in the direction of beams Nos. 1, 4-6, 9; K3202 – cold moderator in the direction of beams Nos. 7, 8, 10, 11; K3203 – cold moderator in the direction of beams Nos. 2, 3; A3 - reactor core, CO - reactor controls, 1-11 - neutron beams

The moderator chamber with cryogenic pipelines forms the first cooling circuit, and the CGU with cryogenic pipelines forms the second cooling circuit. After reaching the operating temperatures of loading (approximately 80-85 K) in all main units and systems of the first and second cooling circuits, the process of loading balls into the chamber begins. The value of the temperature at which the loading takes place should be slightly higher than the freezing point of liquid nitrogen (63.29K), which, due to the technological features of the manufacture of balls, can enter the pneumatic line along with the balls. Loading at a lower temperature can lead to its freezing in the heat exchanger that connects the first and second cooling circuits, loss of flow in the pneumatic conveying pipeline and, as a result, to the termination of cooling. The trapped nitrogen and gas from the atmosphere during the loading of the balls are removed from the system using liquid nitrogen traps. Cooling of the secondary circuit to low temperatures is ensured by helium circulation through pipelines from the CHP to the heat exchanger and back. The cooling of the primary circuit occurs due to the circulation of helium in it and its passage through a heat exchanger located in a vacuum insulated cryostat. The constant pressure inside the transport pipeline is 1.01 atm. and supported by a gas tank.

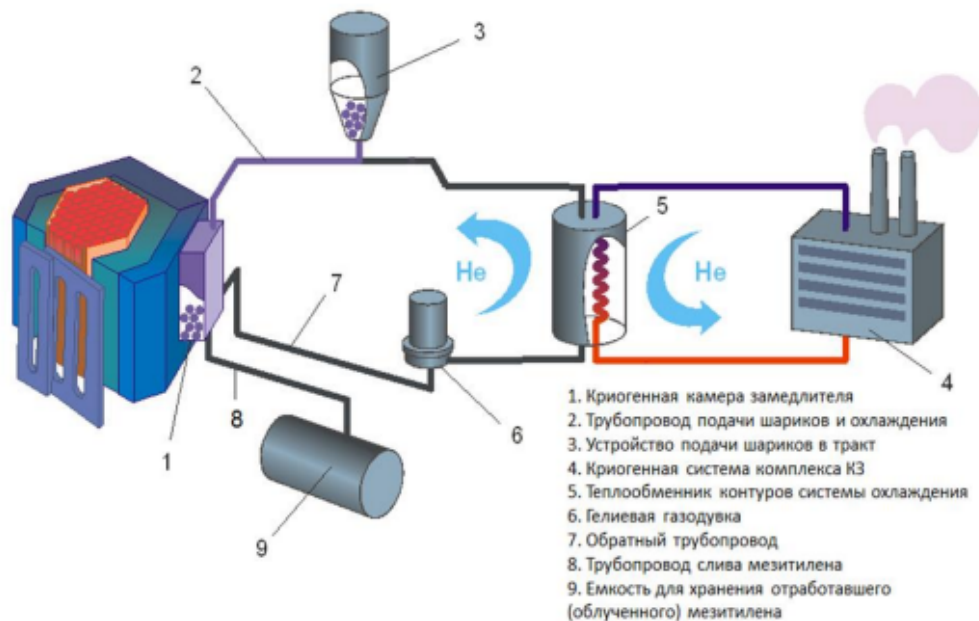
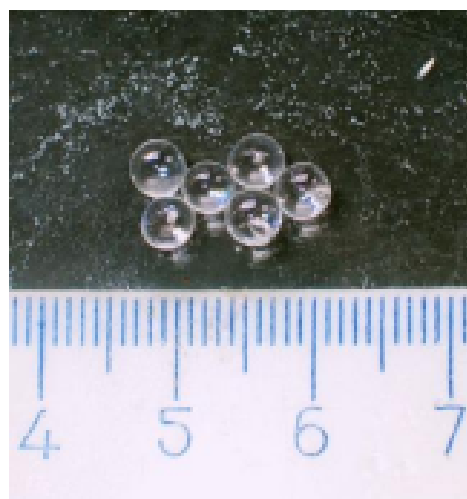

**Fig. 9.** Schematic diagram of the operation of the cold neutron source of the IBR-2 facility based on dispersed mesitylene

The values of the parameters of the optimal mode for loading balls into the cold moderator chamber in the direction of beams Nos. 7, 8, 10 and 11 of IBR-2: helium flow rate in the pipe is 11 - 14 m/s, the average speed of the balls during loading is 2.5 - 3 m/s, the rate of supply of balloons from the dispenser is up to 8 pcs/sec, the temperature of the transporting helium when loading balloons is 80-85 K. The selected parameters provide prompt loading of the moderator chamber in about 4 hours, without destroying the balloons during pneumatic transport [8]. The dispersed loading of the cryogenic chamber also determines the minimum ball diameter of 3.5 mm. Otherwise, the gap between the balls will be insufficient for pumping cooling helium through the cryogenic chamber. The mass flow rate of helium in the pipeline is 1.6 - 3 g/s, such a flow rate ensures the speed of the balls from 2.3 to 3.2 m/s. With a ball diameter > 3.9 mm, a blockage occurs in the pipeline.



**Fig. 11.** Balls from a mixture of mesitylene with m-xylene in liquid nitrogen



**Fig. 12.** Balls on the background of the ruler (one small division of the ruler corresponds to 1 mm)

Pre-prepared frozen balls in portions of 250 ml are placed inside the dosing device. from which they periodically, in portions of several pieces, fall into the inner pipe of the pneumatic line.

From the dispenser, the balls are transported by a flow of cold helium to a chamber (has the shape of a parallelepiped. The dimensions of the inner chamber of the moderator with material are 180 x 40 x 180 mm<sup>3</sup>) installed in a vacuum casing.

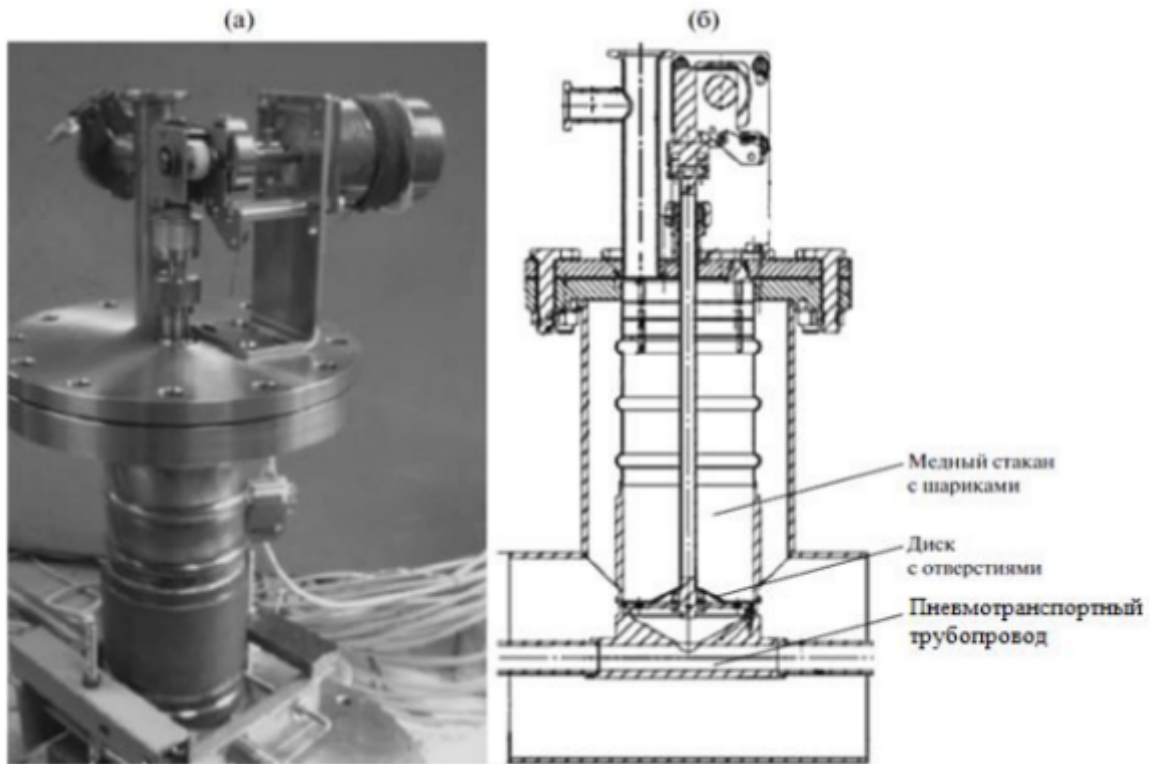

Fig. 10. Dispenser: a) copper cup with balls, b) drawing version

Frozen balls enter the chamber and, lingering on the grate, gradually fill the chamber. To fill the retarder chamber, it is necessary to load 1 liter of frozen balls. After the loading is completed, the chamber with balls is cooled to an operating temperature of 30 K. At this temperature, the moderator can operate during the entire cycle of the IBR-2 reactor at a power of 2 MW [8, 16].

After completion of work, the cryogenic gas installation (CGU) is stopped. The blower and vacuum pumps are turned off, which leads to heating of the first and second cooling circuits and melting of the balls. After shutting down the reactor (power reduction to zero), the molten working material is removed into a special container for draining and disposal [16, 17], after which the moderator is prepared for the next cycle.

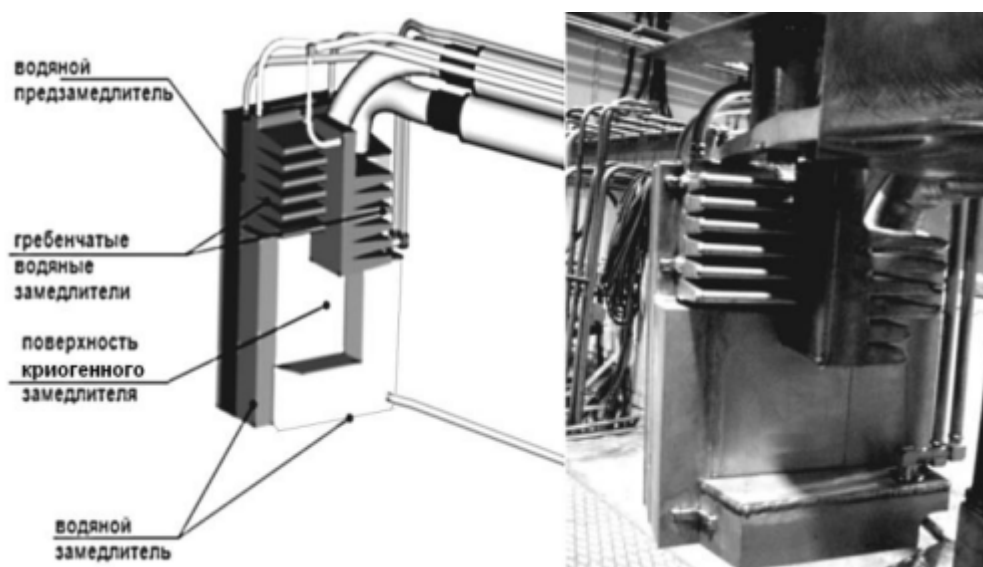

Fig. 13. Bispectral neutron moderator of the IBR-2 reactor



### 3. Current Installation for the production of mesitylene balls

The principle of operation is based on the formation of an ice ball from a mixture of mesitylene and m-xylene (in a ratio of 3 to 1) on the surface of liquid nitrogen. A drop of a liquid substance, having a comparable density ( $0.808 \text{ g/cm}^3$  for liquid nitrogen and  $0.87 \text{ g/cm}^3$  for liquid mesitylene), is located on the nitrogen surface, held by ascending vapors, and after the formation of a solid shell, its density increases simultaneously with a decrease in the flow of ascending vapors by reducing the temperature, and the formed ball sinks. Before the formation of a hard and cold shell, sticking of balls is possible if there are more than one of them on the surface. When it enters liquid nitrogen, the opposite Leidenfrost effect occurs [25]. The formation of a spherical ball occurs due to surface tension forces. Getting on the surface of nitrogen, the ball goes through 3 stages before completely freezing: it cools to the melting point, freezes at a constant temperature, cools down to the temperature of liquid nitrogen [26]. The time of complete freezing of one ball when using the installation was experimentally determined - it is 30 seconds.

The device for preparing balls is a cryostat isolated from the outside by a foam pad and a vacuum jacket. Cylinders (honeycombs, 19 pieces) are located inside to form each ball in a separate volume and prevent balls from sticking together.



**Pic. 14.** Device for mass preparation of solid balls from a mixture of mesitylene and m-xylene: a general view of the device from the side, honeycombs with balls and a metal container with a dropper

The lid is a container where a liquid mixture is poured (900 ml to obtain 1 liter of balls). At the base of the cover, droppers are installed according to the number of "honeycombs" in the cryostat. One dropper contains 19 nozzles.

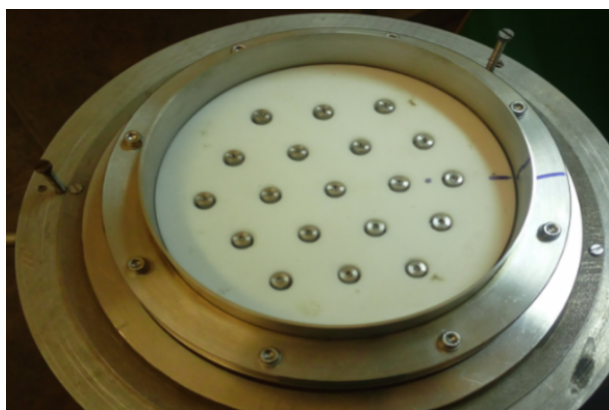

**Pic. 15.** Upper part of the dropper (top view)



**Pic. 16.** Upper part of the dropper (view from below)

A special adjusting screw controls the flow rate of the mixture into the nozzle. This is done so that the drop comes off the nozzle at a strictly defined moment, so that its size falls within the dimensions of 3.5-4 mm. The approximate separation time of a drop from the nozzle is 30 seconds.



**Pic. 17.** Disassembled nozzle



**Pic. 18.** Assembled nozzle

As a result of manufacturing, the balls are obtained with a diameter of 3.5 - 4 mm. Frozen balls sink and are subjected to size selection - it is necessary to weed out balls whose size does not fit into the range of 3.5-4 mm. The selection process is carried out manually by sieving on a mesh separator, which is located inside the cryostat in which the honeycombs are inserted.

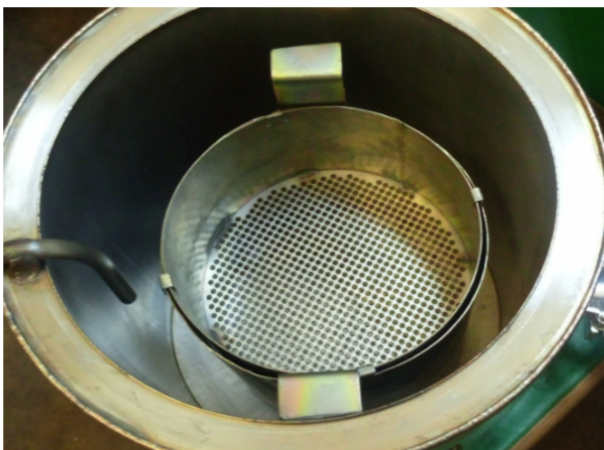

**Pic. 19.** Upper screening mesh with a mesh diameter of 4 mm



**Pic. 20.** Bottom screening mesh with a mesh diameter of 3.5 mm

The balls are stored in the separator until the process of their manufacture is completed. The production speed is 80 balls/min. Then, together with liquid nitrogen, the balls are poured into a measuring container and sent for storage in a Dewar vessel.



**Pic. 21.** Ready sifted balls in nitrogen before loading

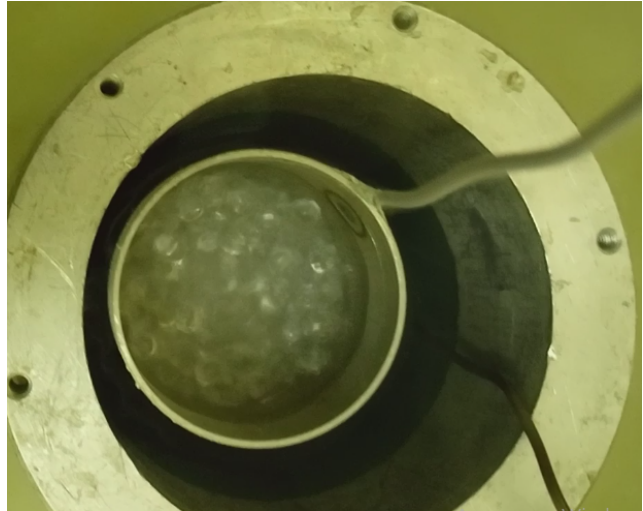

**Pic. 22.** Finished sifted balls in a Dewar

19 nozzles give out 19 drops in 30 seconds. One load of cryogenic moderator requires 1 liter of balls. One bead has a volume of  $\sim 0.03$  ml. Hence,  $\sim 34,000$  balls are required for one load. One dropper generates that much in about 14.9 hours. The IBR-2 reactor has two cryogenic moderators (CS201 and CS202). They need 2 liters of balls. Making them on an existing dropper will take approximately 29.8 hours.

#### 4. The concept of an automatic Installation for the production of mesitylene-m-xylene beads

Breaks between cycles at the IBR-2 reactor are 3-4 weeks. During this time, it is possible to produce the required 2 liters of balls and 1 spare liter on the current Installation. At the moment, a new pulsed reactor IBR-3 "NEPTUNE" with fuel based on neptunium nitride is being developed. The neutron flux from the new reactor will be an order of magnitude higher than that from IBR-2 [6]. Therefore, the loading and unloading of mesitylene-m-xylene beads from the moderator chamber will need to be done once a day. The new reactor is planned to have from 5 to 10 cryogenic moderators. Therefore, to ensure the normal operation of cryogenic moderators, it is necessary to produce 6-12 liters of calibrated balls per day (the current Installation produces 1.6 liters during continuous operation).

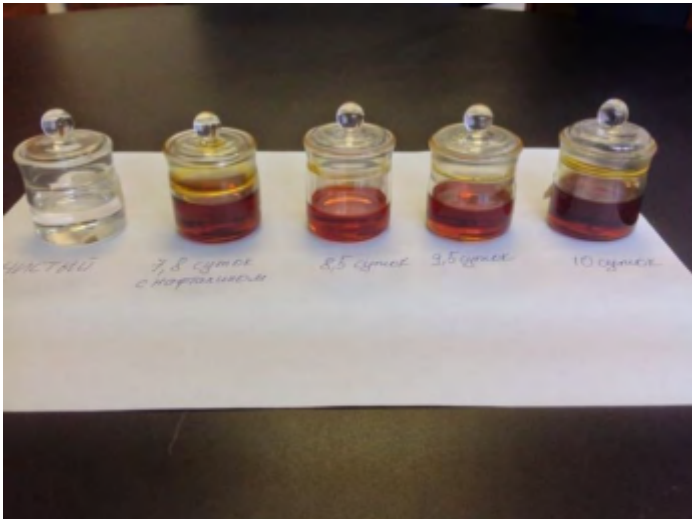

**Pic. 23.** Change in the color of the merged mixture of mesitylene and m-xylene after operation of the cold moderator at IBR-2 (from left to right: the pure mixture from which the balls are made, the mixture with naphthalene after 7.8 days of irradiation of the balls, the pure mixture after irradiation of the balls for 8.5 days, pure mixture after irradiation of the balls for 9.5 days, pure mixture after irradiation of the balls for 10 days) and molten strongly irradiated mixture

Automation of the manufacturing process occurs due to a movable dropper, pumping the mixture and forming drops using a peristaltic pump, increasing the number of cells and automatically transporting finished balls to a storage chamber without the presence of liquid nitrogen in it.

The mobility of the dropper is provided by a CNC stand that allows you to move it along the work plane. For control, a program is written that sets the speed of movement, the final position and the start time of movement.



**Pic. 24.** CNC stand with one nozzle

**Pic. 25.** Top view during work

The number of nozzles in the dripper depends on the maximum number of nests in the peristaltic pump. With the help of the pump it is possible to set the volume of the drop, the time of separation from the nozzle and the period of drop formation. It is important that only one drop of the mixture gets into each nest and not on the walls of the “honeycomb”. To do this, the movement of the dropper is synchronized with the operation of the pump.



**Pic. 26.** Peristaltic pump



**Pic. 27.** Pump next to the stand and cryostat

For experiments, a Shenchen Lab 2015 pump is used with the ability to connect 12 nozzles and without the ability to programmatically synchronize the flow of the mixture with the movement of the dropper. A “drip” period of 2 seconds was chosen so that the nozzles change position and the drops fall into the desired cells of the honeycombs and not onto the walls. The ball takes 30 seconds to solidify, during which time one nozzle can produce 15 drops. Therefore, it is possible to set up 180 cells (honeycombs and possibly spaces between them as cells) for mesitylene-m-xylene beads. This gives a capacity of 21600 balls per hour. There are approximately 34,000 drops in a liter of balls. Then it takes 9.4 - 18.9 hours to produce 6-12 liters.

The balls are transported using an Archimedes screw, with a gap (1mm) between the edge of the screw and the wall to allow the nitrogen to drain. Then the balls fall on a sorting belt with a hole diameter of 3.5 to 4 mm. From the tape, a dispersed substance of the required size enters a container surrounded by liquid nitrogen behind the walls, where it is stored for as long as required.

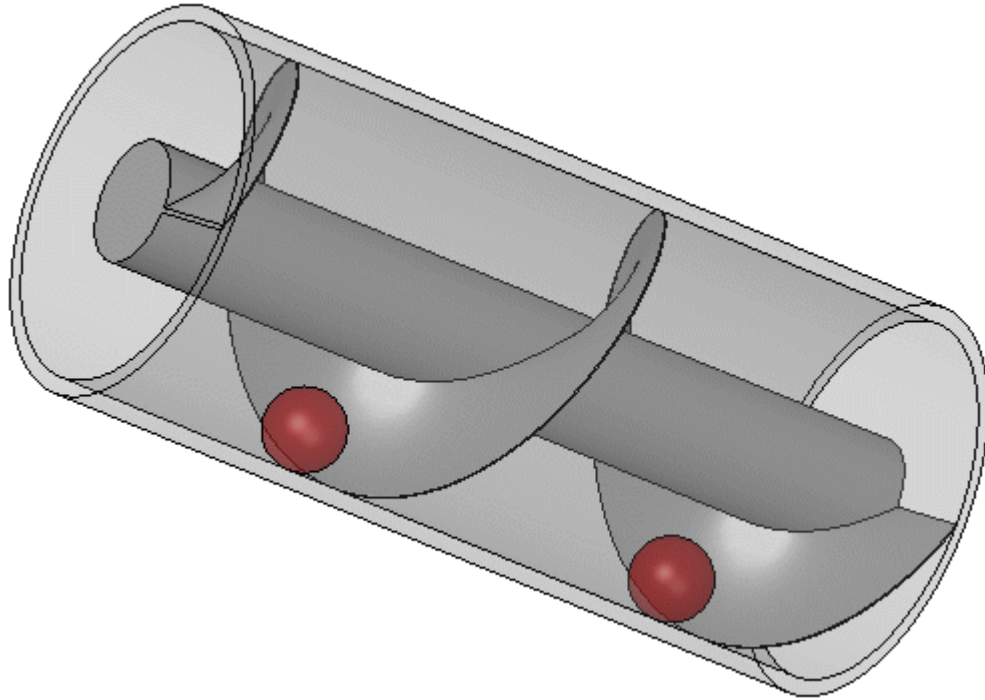

**Pic. 28.** Schematic representation of the Archimedes screw (without clearance)

## 5. Analysis of operating principles, possible problems and options for their solution

An automatic ball generator requires synchronization and proper continuous operation of all nodes during the required period of time. The vapor contained in the air condenses on the walls of the dropper and enters in the form of ice into a container with balls. If ice enters the supply pipe, a blockage will form and the balls will get stuck in the pipe, which means that this effect must be eliminated. The temperature of the nozzle affects the adhesion of the drop, which leads to a change in the separation time and bead size. Adhesion is also affected by the material and shape of the nozzle. It is required to maintain the same level of liquid nitrogen in both the production tank and the balloon storage tank. Tubes for supplying the mixture should not change shape when interacting with it. Ready-made balls should fall dry and whole into a storage container, being sorted according to the desired size.

To solve the problem of air ingress and ice formation, it is planned to produce generation in sealed conditions in a nitrogen atmosphere. In this case, there will be a low temperature inside the sealed casing, which can affect both the operation of the tubes for supplying the mixture and the operation of the nozzles - the mixture will simply freeze in them. To prevent this from happening, it is planned to heat the dropper, thereby heating both the nozzles and the tubes from above, and also to control the temperature of each node using temperature sensors. In addition, temperature and air pressure affect the formation of a drop (size and separation time), which requires additional study to select the optimal operating conditions for the pump and the movement of the dropper. It is also necessary to check the functioning of moving parts in low temperature conditions.

The effect of nozzle size and shape on adhesion requires further study. In the near future nozzles with an angle at the hole of 60, 90 and 120 degrees and diameters of 2.1, 2.3, 2.5, 2.7 mm will be tested



**Pic. 29.** Nozzles with a diameter of 2.5mm, from left to right 60, 90 and 120 degrees, respectively



**Pic. 30.** Nozzles with a diameter of 2.1, 2.3, 2.5, 2.7 mm, bottom-up: 60, 90 and 120 degrees

To control the level of liquid nitrogen, it is necessary to develop or find sensors that will give a signal to increase the level of liquid nitrogen, withstanding low temperatures.

The problem with changing the shape of the tube under the influence of the mixture was solved by testing 10 different tubes. The test samples were cut in half and the first halves were placed in the mixture for an hour. At the end of this time, the outer diameter and wall thickness of each sample were measured and compared with the original. Suitable were: "VERSILON (Fluran) F-5500-A", as an alternative, you can use the tubes "Tygon F-4040-A" or "Viton". After a month of tubes being in the mixture, the dimensions remained the same as after an hour. The results of the experiments are shown in table 2.

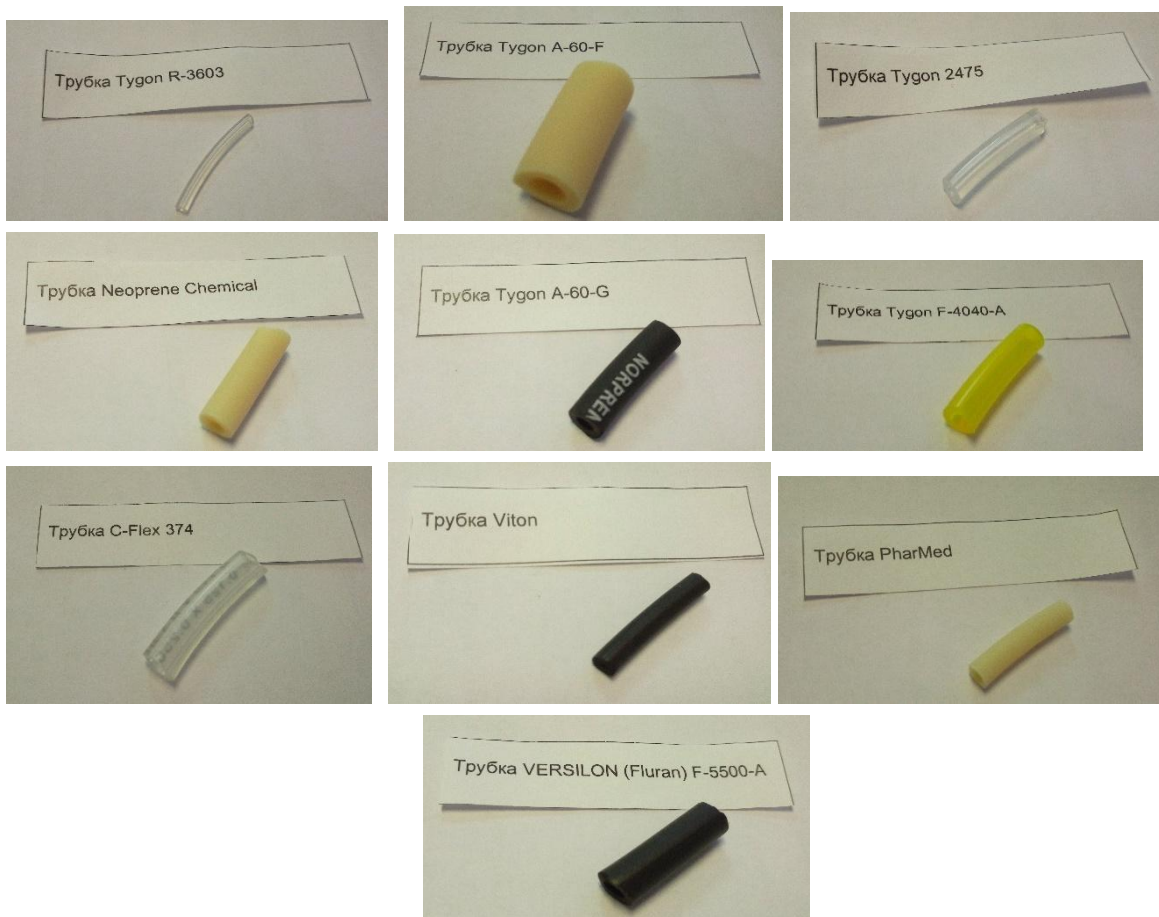

**Pic. 31.** Photos of test tubes, left to right: Tygon R-3603, Tygon A-60-F, Tygon 2475, Neoprene Chemical, Tygon A-60-G, Tygon F-4040-A, C-Flex 374, Viton, PharMed and VERSILON (Fluran) F-5500-A

**Table 2.** The results of testing the tubes for resistance to a mixture of mesitylene (75%) and m-xylene (25%)

Name	Diameter before exposure, mm	Diameter after exposure, mm	Wall thickness before exposure, mm	Wall thickness after exposure, mm	Change in diameter and wall thickness, %
Tygon R-3603	2,27	2,06	0,87	0,84	9,3 и 3,5
Tygon A-60-F	11,19	13,24	2,56	3,27	18,3 и 27,7
Tygon 2475	4,64	6,69	1,8	2,39	44,2 и 32,7
Neoprene Chemical	6,34	7,29	1,95	2,08	14,9 и 6,7
Tygon A-60-G	6,48	7,72	1,97	2,47	19,1 и 25,4
Tygon F-4040-A	6,45	6,44	2,01	2,05	0 и 0*
C-Flex 374	6,08	6,37	1,97	1,73	4,8 и 12,2
Viton	4,15	4,17	1,66	1,76	0 и 6*
PharMed	4,71	5,38	1,16	1,14	14,2 и 0*
VERSILON (Fluran) F-5500-A	6,55	6,55	1,95	1,95	0 и 0*

\* - (within measurement error)

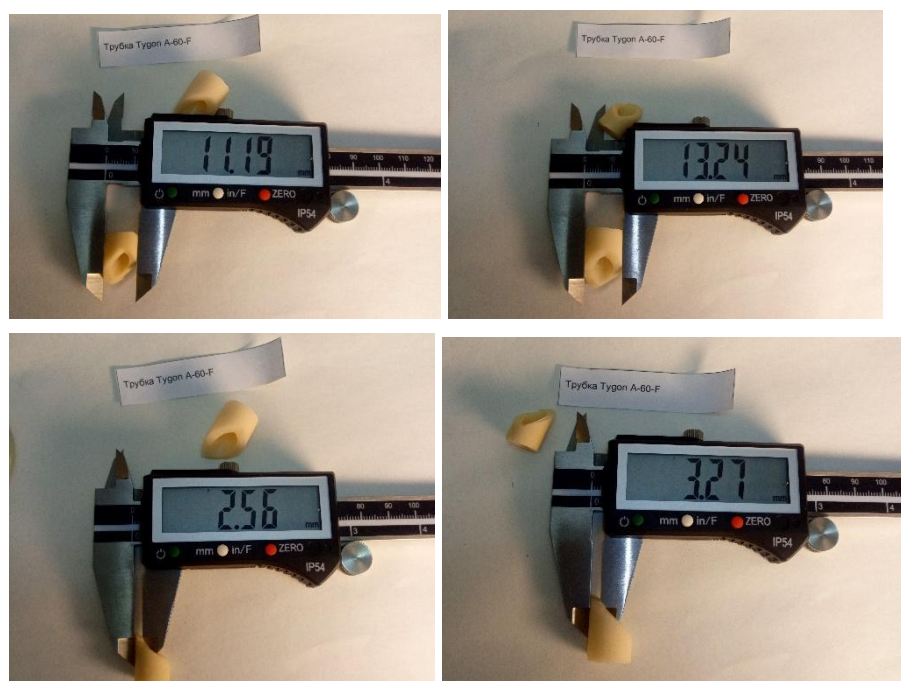

**Pic. 32.** Measurement examples for the Tygon A-60-F tube. Top - diameter, increased by 18.3%, bottom - wall thickness, increased by 27.7%



In order for the balls not to be damaged and get rid of nitrogen during their transportation to the storage place, it is necessary to maintain a temperature of about 80 K throughout the entire path of the balls. This can be done by blowing the moving balls with a counter flow of helium at a given temperature. This will both cool the balls and rid them of liquid nitrogen residues on the surface.

## 6. Methane pellets for moderators in medium and small reactors

The presence of low-lying excitation levels in methane (Figures 3, 12 [18]), together with a relatively high proton density (Table 3), makes methane the best in terms of neutron moderation among other materials.

**Table 3.** Some physical properties of materials for cold neutron moderators

Material	Temperature, K	Density, g/cm <sup>3</sup>	Proton density, p/cm <sup>3</sup> x 10 <sup>24</sup>	Melting and boiling point (1 atm.), K
H <sub>2</sub> O	293	0,92	0,061	273, 373
H <sub>2</sub>	20	0,0708	0,042	14, 21
CH <sub>4</sub>	25	0,528	0,079	90, 110
C <sub>2</sub> H <sub>6</sub>	173	0,561	0,068	90, 184
C <sub>3</sub> H <sub>8</sub>	228	0,523	0,064	83, 231
C <sub>9</sub> H <sub>12</sub> , mesitylene	293	0,8652	0,0649	228, 438

Solid methane at normal pressure is in an orientationally disordered I-th phase, up to a temperature of 20.4 K. In this phase, all CH<sub>4</sub> molecules can easily rotate around the center of mass and the low rotational energy of the excitation of the crystal lattice plays the most important role in deeply slowing down neutrons [16].

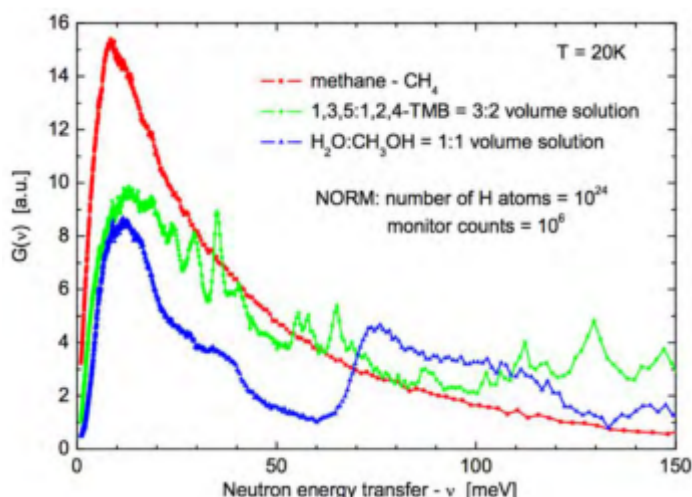

**Fig. 33.** Comparison of the  $G(v)$  (vibrational densities of states) neutron spectra from solid methane and the neutron spectra of a mixture of liquid mesitylene (1,3,5-TMB) and pseudocumene (1,2,4-TMB) in the amorphous state (3:2 volume parts) and 1:1 water-methanol solution.  $G(v)$  spectra are normalized to the same number of hydrogen atoms and the number of incident neutrons. The volume and thickness of the studied samples are identical [19]

At the same time, low radiation resistance (formation of radicals and radiolytic hydrogen) does not allow the use of methane in the solid state at powerful sources without its periodic replacement in the moderator chamber and distillation of radiolytic

hydrogen by heating the moderator to temperatures close to the melting points of methane.

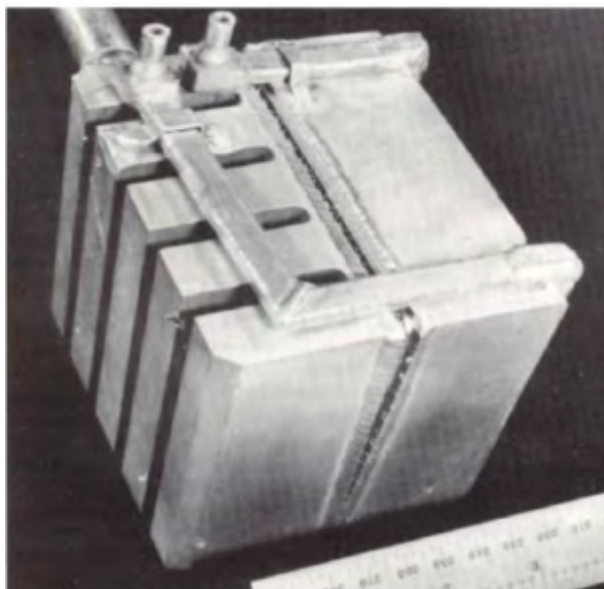

**Pic. 34.** Destroyed methane moderator IPNS [20]

The accumulation of radiolytic hydrogen and radicals in solid methane under training, as well as the accumulation of resins in the moderator chamber with methane [21], leads to a decrease in the cold neutron flux and the need for frequent chamber replacement, which significantly limits the use of methane in cold moderators.



(a)



(b)

**Pic. 35.** Accumulation of deposits of tar and other formations in the moderator chamber after methane irradiation (b) compared to the new one (a)

As a result of exothermic chain reactions of recombination of accumulated radicals, methane is heated, but the radiolytic hydrogen accumulated in the volume of solid methane does not leave it until a certain temperature is reached, but creates pressure inside the material and on the walls of the moderator chamber.

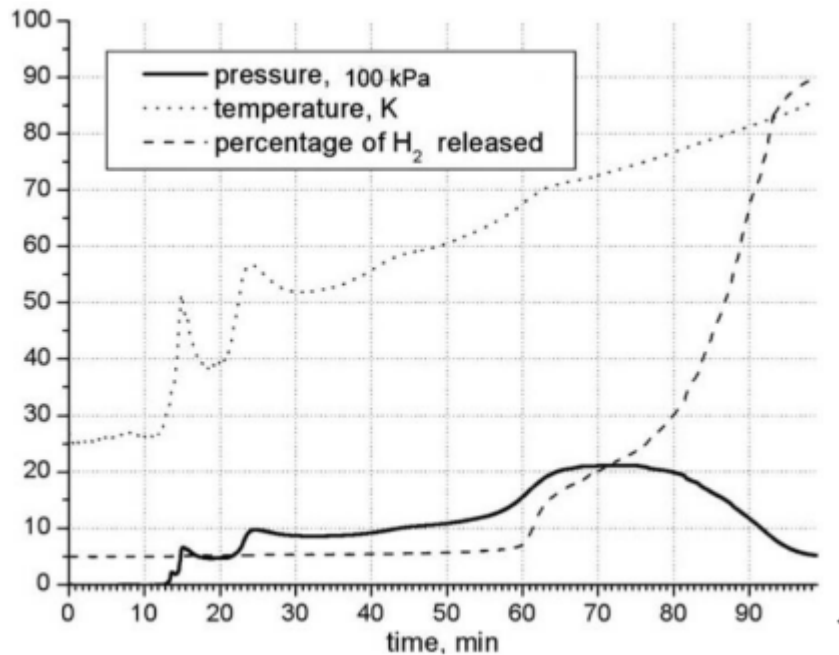

**Pic. 36.** Indications of parameters in the process of heating solid methane after irradiation at the IBR-2 reactor for 15.5 hours at a temperature of 25-26 K (one hour of irradiation = 0.81 MGy): solid line - pressure on the chamber walls in kPa; the dashed line is the percentage of hydrogen released from methane; dashed line with dots - methane temperature

The operation of cold moderators based on solid methane has repeatedly led to the destruction of chambers at neutron sources, and also requires frequent replacement when used at high power sources. At the same time, the creation of a moderator based on methane balls will increase the yield of cold neutrons on sources of medium and low power with good safety indicators and a uniform temperature throughout the volume of the moderator chamber, as well as simplify the release of hydrogen, in comparison with a monolithic piece of solid methane.

## 7. The concept of an automatic Installation for the production of methane pellets

The principle of formation of a ball from methane is similar to the principle of formation of mesitylene-m-xylene: a drop of a liquid substance falls on the surface of a liquid coolant, after which it freezes.

The device for preparing balls is a cryostat isolated from outer space by a vacuum jacket with a double-circuit cryogenic installation. Inside there are: a methane gas condensation chamber, a liquid nitrogen cavity, drop formers with adjusting screws, a liquid helium cavity, frozen balloon separators and a device for transferring finished balloons to a storage location.

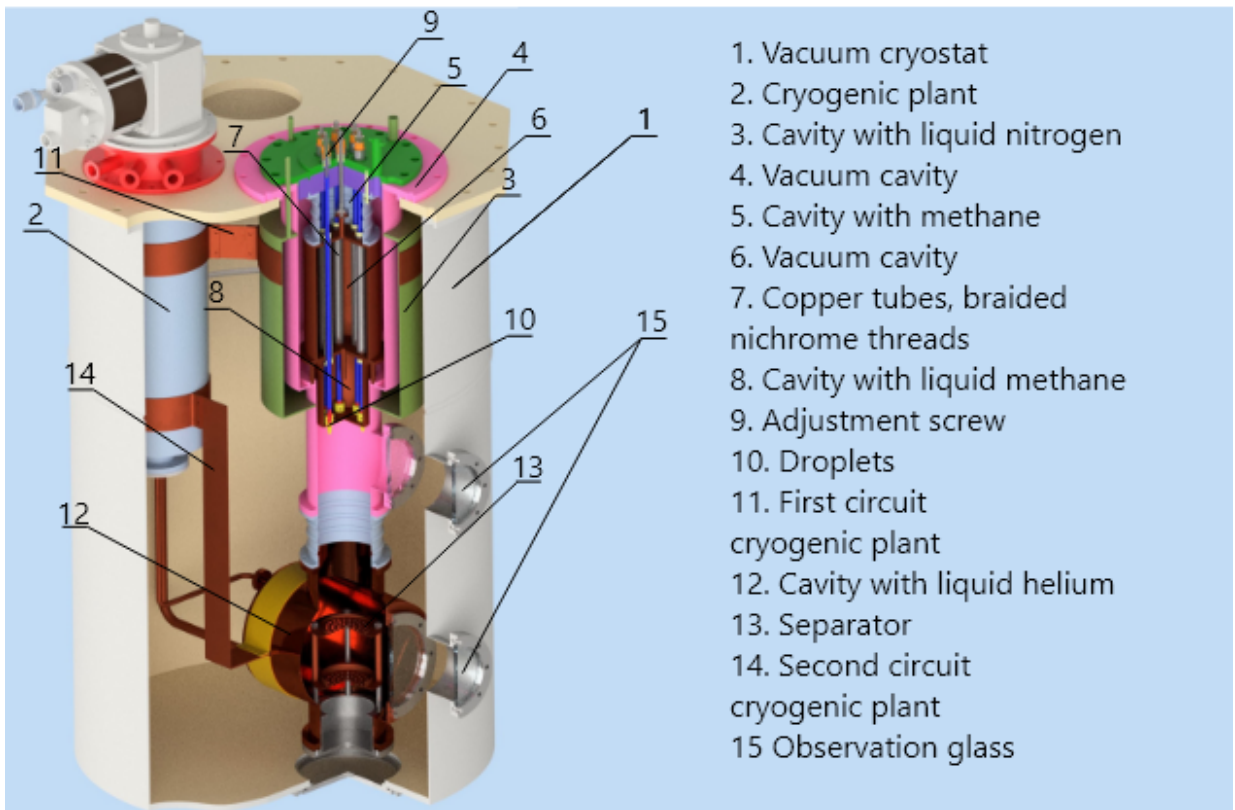

**Pic. 37.** 3d model of a device for generating methane balls

Gaseous methane under atmospheric pressure is supplied from the gas tank to the condensation chamber. It consists of three cavities: gaseous methane is fed into the first one, the second one heats copper tubes (by creating a vacuum), and the third one contains liquid methane and drop formers with adjusting screws. The first and third cavities are connected by copper tubes, on the walls of which methane condenses. The tubes are cooled through a copper heat exchanger, which is cooled with liquid nitrogen. Nitrogen is cooled by the first circuit of the cryogenic Installation. There are 13 copper tubes in total. They are surrounded by nichrome threads for heating the tubes in case of methane freezing. Under the action of gravity, the condensed methane moves down the tubes and collects in the third cavity. At the bottom, 4 drop formers are installed, similar in principle to the nozzles of the current installation for creating mesitylene-m-xylene balls. It may be necessary to install heaters on the drop formers as well.

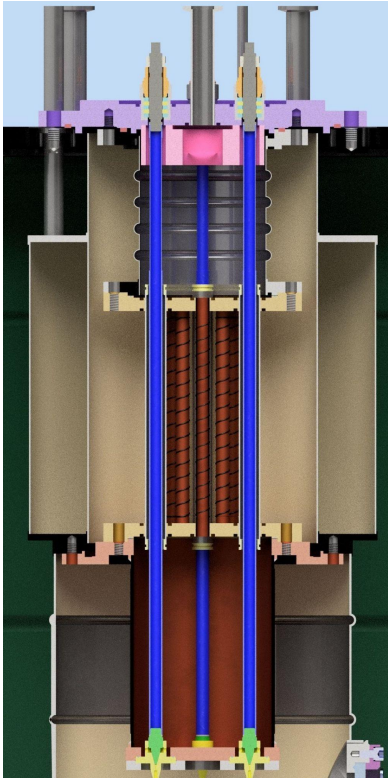

**Pic. 38.** Methane drip

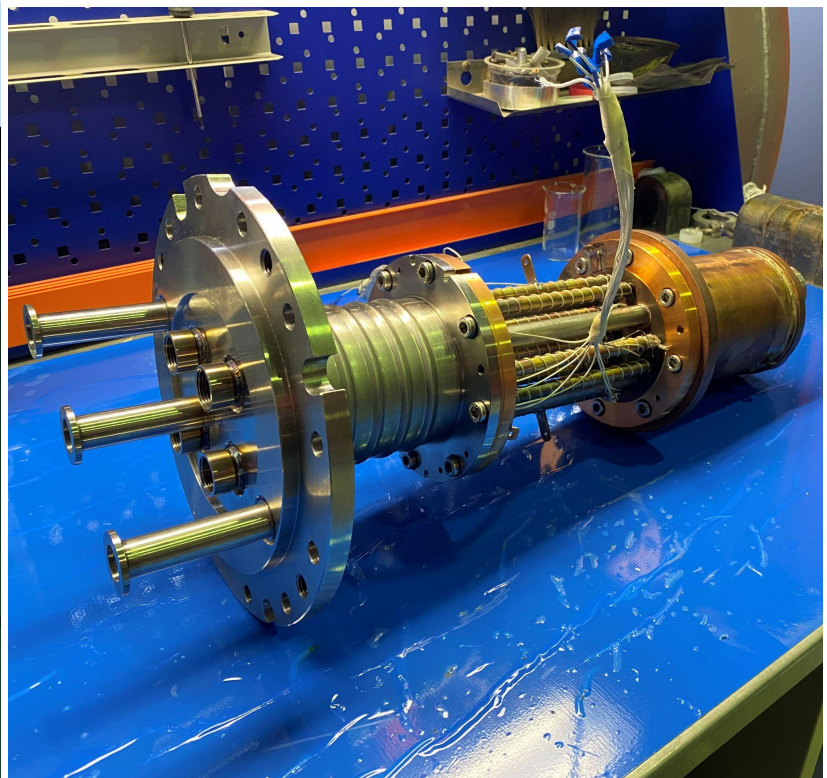

**Pic. 39.** Condensation cell

Next, a drop of methane enters a chamber with liquid helium, where it freezes. Helium is cooled by the second circuit of the cryogenic Installation. The exact behavior of a methane droplet in both liquid nitrogen and liquid helium is currently unknown. It is assumed that the ball will not sink in liquid nitrogen after the transition to a solid state of aggregation (the density of liquid nitrogen is  $0.808 \text{ g/cm}^3$ , the density of liquid methane is 2 times less -  $0.415 \text{ g/cm}^3$  and such a sharp increase in density during freezing is not expected), in the near future For the time being, an experimental study of the behavior of a drop of liquid methane and a solid ball in liquid nitrogen, and later in liquid helium, is planned. It is likely that the methane ball will start to sink in liquid helium (the density of liquid helium is  $0.13 \text{ g/cm}^3$ ), but the behavior until the ball is completely frozen due to ascending helium vapors is unknown (The specific heat of vaporization of liquid helium at  $4.2 \text{ K}$  is  $20.7 \text{ kJ/mol}$  [27] , which is an order of magnitude less than that of nitrogen -  $2 * 10^5 \text{ J/kg}$ , which will enhance the reverse effect of Leidenfrost [26]).

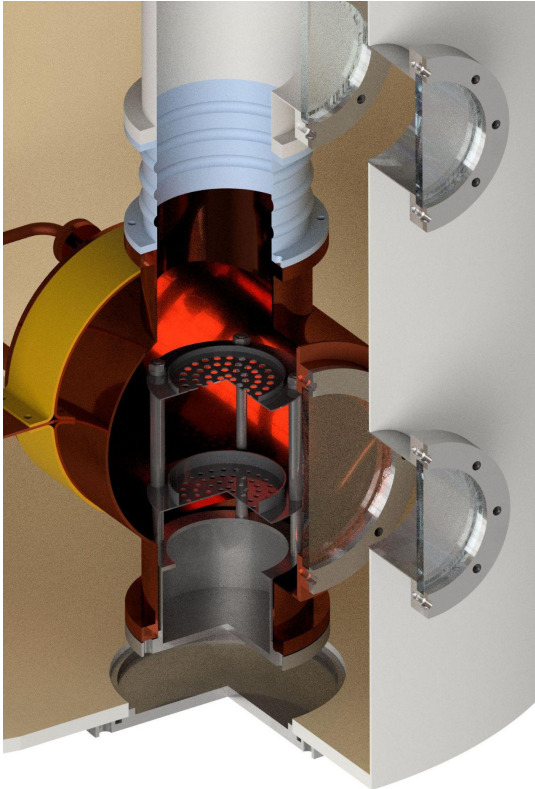

**Pic. 40.** 3d model of a helium cell



**Pic. 41.** helium cell next to the cryostat

The impossibility of using liquid nitrogen as a coolant is due to both the extremely close melting and boiling points of methane and nitrogen (90.66 K and 111.57 K, 63.29 K and 77.4 K, respectively), and the high adhesive properties of methane in the temperature range 50–90 K [22, 23], which are lost at a temperature of 20–30 K [23, 24]. This makes it extremely difficult to separate the nitrogen from the methane balls without them sticking together or freezing liquid nitrogen, making the production process extremely complex and poorly scalable. Due to entering helium at a temperature of 4.2 K, methane will cool to a temperature at which it will lose its high adhesive properties and it will simply be transported to a storage chamber, and balls can be loaded into the pipeline along with liquid helium, which simply evaporates into the helium present there, leaving dry methane balls.

The extremely low temperature of the liquid helium (4.2 K) imposes stringent requirements on thermal insulation, making it difficult to transport the balloons to the storage room, despite the fact that it is not necessary to separate the helium from the balloons. It is possible to use moving liquid helium in a pipe at an angle if it is possible to create the necessary thermal insulation conditions. In this case, a drop of methane falls into the helium flow and follows into the separator, after which the frozen ball enters the storage chamber. The effect of fluid motion on bead formation is not known, as motion can influence the occurrence of the inverse Leidenfrost effect.

Another inert gas, neon, has a suitable boiling point (27.1 K, 1 atm.), but has a low prevalence (18.2 ml of air is contained in 1 m<sup>3</sup> of air) and requires the development of an installation for its liquefaction, which affects the cost of obtaining balls. In addition, the melting point of neon at 1 atm is 24.55 K, which differs very little from the boiling point and requires precise temperature control during operation.

## Conclusion

The development and implementation of cold neutron sources is a complex and multifaceted work that requires both extensive theoretical research and a large number of experiments in various fields of physics. The choice of the material that will be used as a working substance is not a trivial task, as well as obtaining it in the required form. This report considered the creation of more productive and unique installations for the production of solid dispersed material, which makes it possible to obtain high fluxes of cold neutrons and cool the substance, creating a small temperature gradient, which reduces the spread of neutron thermalization in the beam; and also makes the operation of cold moderators safer, which is critical for use in pulsed reactors, which are ten times more sensitive to geometry changes than stationary ones. The material currently used in the cryogenic moderators of the IBR-2 reactor, mesitylene-m-xylene, has the best safety indicators and is relatively easy to manufacture and operate, while simultaneously having high thermalization and neutron yield rates. Methane, on the other hand, is more demanding on operating conditions and is difficult to manufacture, but it allows obtaining the best neutron flux and thermalization. One of the options for improving operating conditions is to create a system for the constant replacement of the working substance in the moderator chamber, which will make it possible to control the received radiation dose and the effects caused by it.

## **Acknowledgments**

I thank the JINR University Center for the START program and the opportunity to participate in it. Bulavin Maxim Viktorovich for detailed explanations, assistance in choosing a topic and creating this report; Galushko Aleksey Viktorovich for demonstrating the installations, detailed explanations of the principles of operation of the installations described in the report, material for the report and discussion of emerging ideas; Chepurchenko Roman Vladimirovich for demonstrating the operation of the current and emerging installation for the production of balls, discussing possible problems, providing information on the work carried out and assistance in conducting and analyzing experiments; Dorofeev Pavel Aleksandrovich for discussions and answers to questions; Petrova Maria Olegovna for detailed explanations of the principles of operation of the detectors and methods for analyzing the neutron and gamma fields near the source, and Yamurzin Vladik Rafikovich for demonstrating the detectors and answering various questions.

## References

1. Некоторые особенности эксплуатации шарикового криогенного замедлителя на основе мезитилена на импульсном быстром реакторе ИБР-2 / М. В. Булавина, К. А. Мухина, А. Ыскакова, А. Д. Рогова, А. В. Галушко, В. А. Скуратова, И. А. Смелянский // ПОВЕРХНОСТЬ. РЕНТГЕНОВСКИЕ, СИНХРОТРОННЫЕ И НЕЙТРОННЫЕ ИССЛЕДОВАНИЯ, 2022, No 1, с. 3–9
2. Myong-Seop Kim, Jungwoon Choi & al. "Measurement of Void Fraction in Hydrogen Moderator Used for Moderator Cell of HANARO Cold Neutron Source" // Proceedings of the 11th Meeting of the International Group on Research Reactors (IGORR 2007) – Lion, France, 2007
3. Алтарев И.С. Универсальный источник холодных и ультрахолодных нейтронов на реакторе ПИК / К.А. Коноплев, В.А. Митюхляев, А.П. Серебров, А.А. Захаров // Препринт ПИЯФ-1704, 1991. Л., 35 с
4. Развитие реакторной экспериментальной базы НИЦ "Курчатовский институт": от пуска Ф-1 до 60-летия реактора ИР-8 / Ковальчук М.В., Ильгисонис В.И., Штромбах Я.И., Курский А.С., Андреев Д.В. // Вопросы атомной науки и техники. Научно-технический журнал. Серия: Физика ядерных реакторов - Выпуск 3, 2017
5. Компактные источники нейтронов для физики конденсированного состояния в России и мире: состояние дел и перспективы / Павлов К.А., Коник П.И., Коваленко Н.А., Кулевой Т.В., Серебренников Д.А., Субботина В.В., Павлова А.Е., Григорьев С.В. // Кристаллография, 2022, Т. 67, № 1, 2022
6. Highly intense pulsed neutron source "NEPTUN" (IBR-3) / Aksenov V., Komyshev G., Shabalin E., Rzyanin M., Lopatkin A., Tretyakov I. // Workshop 6-7 Dec. 2018, Dubna
7. Источник холодных нейтронов реактора ИБР-2 на основе дисперсного мезитилена с системой охлаждения : автореферат дис. ... кандидата технических наук : 01.04.01 / Мухин Константин Александрович; [Место защиты: Объед. ин-т ядер. исслед. (ОИЯИ)]. - Дубна, 2019. - 26 с
8. Шариковый холодный замедлитель реактора ИБР-2 : некоторые аспекты создания и применения: автореферат дис. ... кандидата физико-математических наук : 01.04.01 / Булавин Максим Викторович; [Место защиты: Объед. ин-т ядер. исслед. (ОИЯИ)]. - Дубна, 2017. - 23 с
9. Шабалин Е.П. // Журн. физика элементарных частиц и атомного ядра. 2005. Т. 36. No 6. С. 1425
10. The world's first pelletized cold neutron moderator at a neutron scattering facility / V. Ananiev, A. Belyakov, M. Bulavin, E. Kulagin, S. Kulikov, K. Mukhin, T. Petukhova, A. Sirotin, D. Shabalin, E. Shabalin, V. Shirokov, A. Verhoglyadov // Nuclear Instruments and Methods in Physics Research Section B: Beam Interactions with Materials and Atoms. Volume 320, 1 February 2014, Pages 70-74
11. Inoue K., Iwasa H., Kiyonagi Y. // J. Atom. En. Soc. Jpn. 1979. V. 21. Iss. 11. P. 865
12. Utsuro, M. Experimental study on a cold neutron source of solid methylbenzene/ M.Utsuro, M Sugimoto, Y.Fujita // Annual report research reactor institute, Kyoto University. – 1975. – Report 8. – P. 17-25
13. Физический пуск модернизированного реактора ИБР-2 (ИБР-2М) / В. Д. Ананьев, А. В. Виноградов, А. В. Долгих, J1. В. Едунов, Ю. Н. Пепельшев, А. Д. Рогов, С. А. Царенков, А. А. Заикин\*, А. А. Локанцев // Сообщение Объединенного института ядерных исследований. Дубна, 2012
14. Текущие характеристики полей ионизирующих излучений облучательной установки реактора ИБР-2 для исследований радиационной стойкости материалов / М. О. Петрова, М. В. Булавин, А. Д. Рогов, А. Ыскаков, А. В. Галушко // Приборы и техника эксперимента, 2022, № 33, с. 5-9
15. Облучательная установка для исследования радиационной стойкости материалов на реакторе ИБР-2 / М. Б. Булавин, А. Е. Верхоглядов, С. А. Куликов, Е. Н. Кулагин, В. В. Кухтин, А. П. Чепляков, Е. П. Шабалин // Письма в ЭЧАЯ. 2015. Т. 12, №2(193). С. 517-523



16. Холодные замедлители нейтронов на основе твердых дисперсных водородсодержащих материалов : автореферат диссертации доктора физико-математических наук : 01.04.01 / Куликов Сергей Александрович; [Место защиты: Объед. ин-т ядер. исслед. (ОИЯИ)]. - Дубна, 2016. - 32 с
17. Solid methane cold moderator at the IBR-2 reactor: test operation at 2 MW / E.P. Shabalin [et al.] // Proceedings of the 2nd international meeting on pulsed advanced neutron sources. – Dubna, 1994. – P. 217-234
18. Comparison of Neutron Scattering and Radiation Properties of Methane and Water Ices with Methyl Derivatives of Benzene at Low Temperatures / I. Natkaniec, E. Shabalin, S. Kulikov, K. Holderna-Natkaniec // In Proc. of 17th Meeting of the International Collaboration on Advanced Neutron Sources, ICANS-XVII, USA , LA-UR-06-3904, Vol. II, pp.519-529, 2006
19. Comparison of Neutron Scattering and Radiation Properties of Methane and Water Ices with Methyl Derivatives of Benzene at Low Temperatures / I. Natkaniec, E. Shabalin, S. Kulikov, K. Holderna-Natkaniec // In Proc. of 17th
20. IPNS Progress Report 1985-1986 / J.M. Carpenter // Argonne National Laboratory, pp. 8-10, 1986
21. The Isis Cold Moderators / G. M. Allen, T. A. Broome, R. A. Burrige, D. Cragg, D. Evans, R. Hall et al. // Proceedings of the International Workshop on Cold Moderators for Pulsed Neutron Sources Argonne National Laboratory, pp.43-54, 1997
22. Adhesion, plasticity and other properties of solid methane / Kirichek O., Church A.J., Thomas M.G., e.a. // Cryogenics. 2012. V.52. P.325.
23. Аномальные свойства кристаллического метана в интервале 60—70 К. эксперимент. теория / А.Ю.Захаров, А.В.Леонтьева, А.Ю.Прохоров, А.И.Эренбург // Вестник новгородского государственного университета №73 Т.2, 2013
24. An Advanced Cold Moderator Using Solid Methane Pellets / C.A. Foster , J.M. Carpenter // ICANS-XV 15th Meeting of the International Collaboration on Advanced Neutron Sources November 6-9, 2000 Tsukuba, Japan
25. Self-propulsion of inverse Leidenfrost drops on a cryogenic bath / A. Gauthier, C. D. Rémi, D. Lohse, D. van der Meer // The Proceedings of the National Academy of Sciences. January 7, 2019 116 (4) 1174-1179
26. Inverse Leidenfrost Effect: Levitating Drops on Liquid Nitrogen / M. Adda-Bedia, S. Kumar, F. Lechenault, S. Moulinet, M. Schillaci, D. Vella // Langmuir DOI: 10.1021/acs.langmuir.6b00574 April 6, 2016
27. Справочник по разделению газовых смесей методом глубокого охлаждения (1963) -- [ с.34 ]