



JOINT INSTITUTE FOR NUCLEAR RESEARCH
Veksler and Baldin laboratory of High Energy Physics

FINAL REPORT ON THE SUMMER STUDENT PROGRAM

*Development of Sensl semiconductor
photoelectric sensor module for Shashlik
calorimeter*

Supervisor:

Dr. Elena Sergeevna
Kokoulina

Student:

Dmitriy Olegovich Strahatov,
Russia,
Altay State Technical
University

Participation period:

July 01 – August 11

Dubna, 2018

Abstract

This report presents the results of the development of the module of the semiconductor photomultiplier Sensel for the study of gallium-gadolinium crystals.

For create an ECAL for the NIKA supercollider (RUSSIA), it is necessary to create a construction that will capture the photons that are obtained during the interaction of particles with the construction like a shashlik (Fig. A, B) [1].

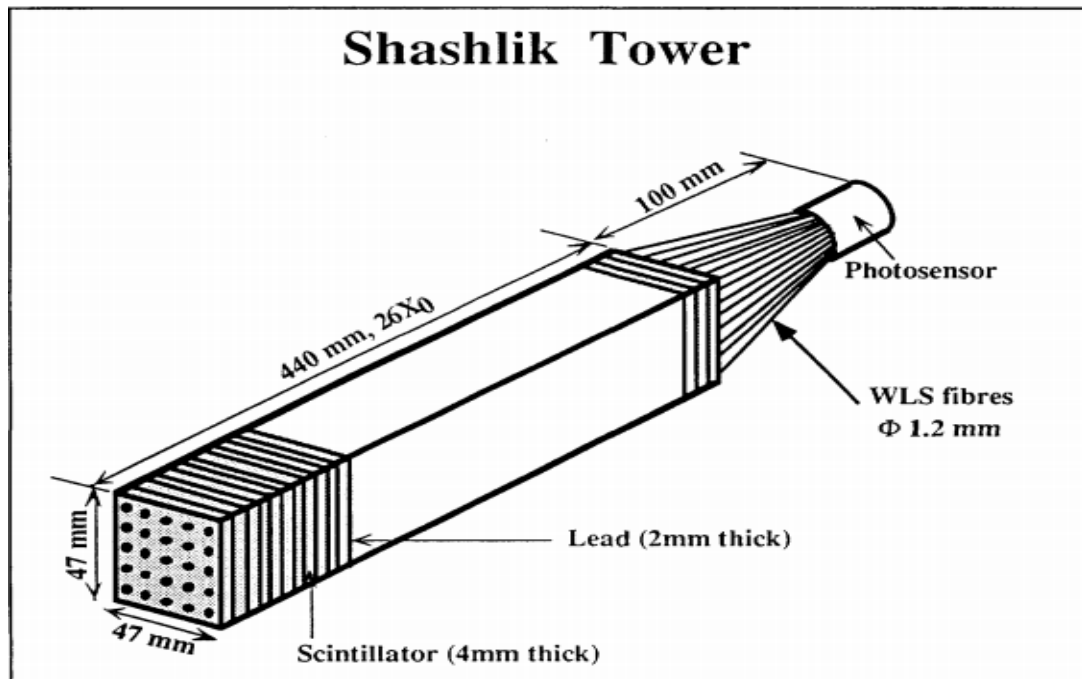

Figure A. The example mechanical design of a CMS Shashlik calorimeter prototype tower equipped with 25 aluminized WLS fibres. Side view.

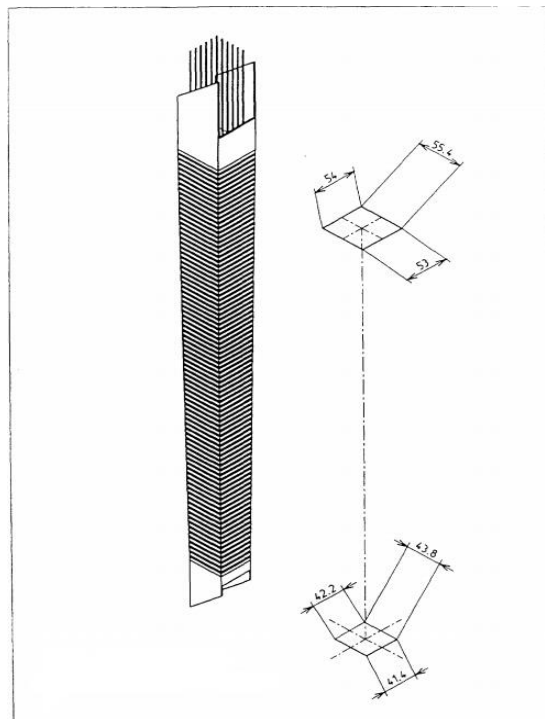

Figure B. The example shashlik tower design. View of face.

The appearance of the calorimeter module is shown in Fig. 1a, 1b and 1c

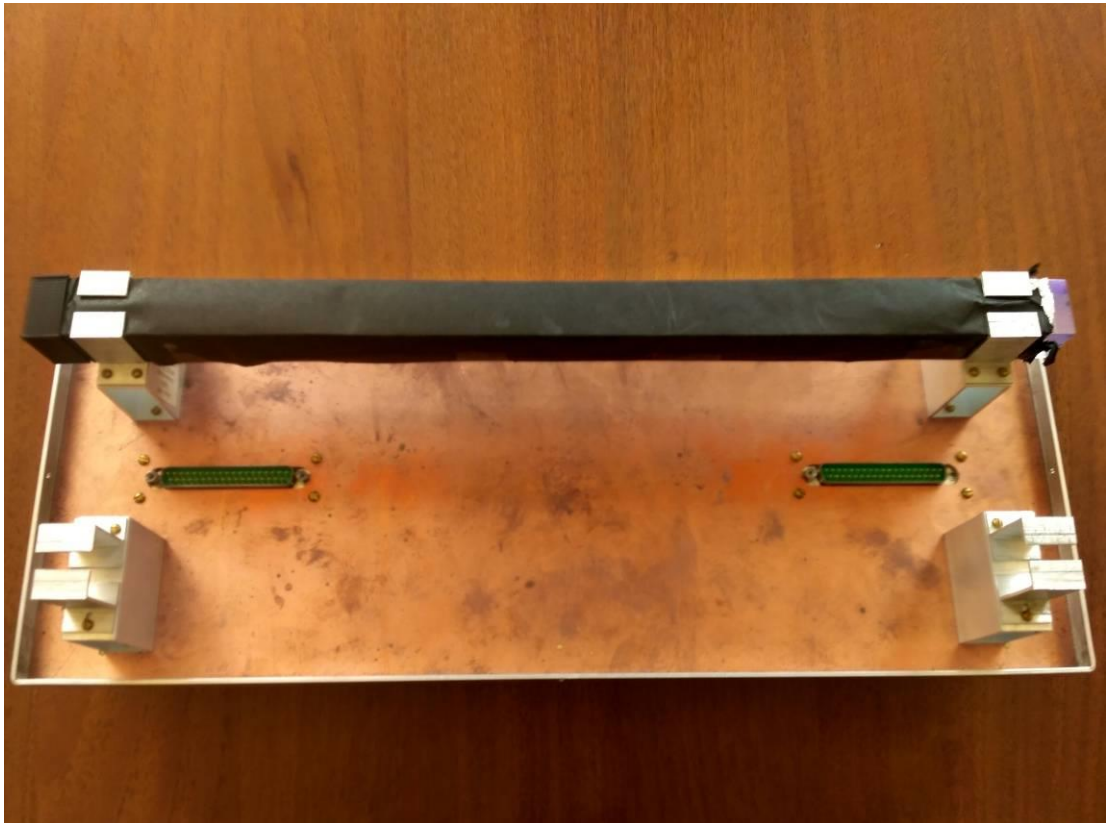

Fig. 1a. Experimental sample of a CMS Shashlik calorimeter prototype tower equipped with 25 aluminized WLS fibres, front view.



Fig. 1b. Experimental sample of a CMS Shashlik calorimeter prototype tower equipped with 25 aluminized WLS fibres, rear view

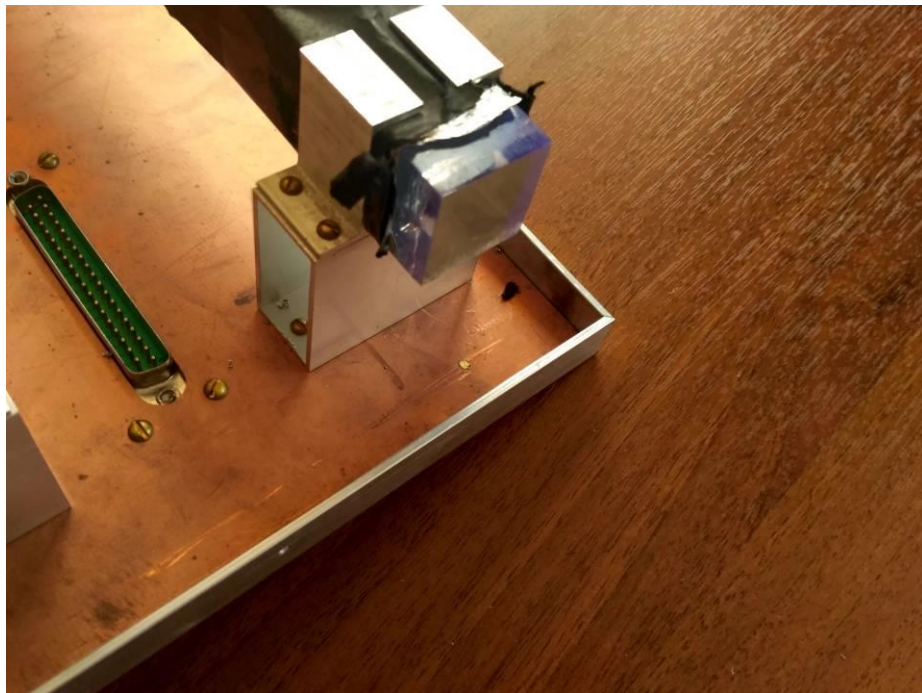

Fig. 1c. Experimental sample of a CMS Shashlik calorimeter prototype tower equipped with 25 aluminized WLS fibres, fibre view

Appearance of Sensl semiconductor photo sensor is shown in Figure 2.

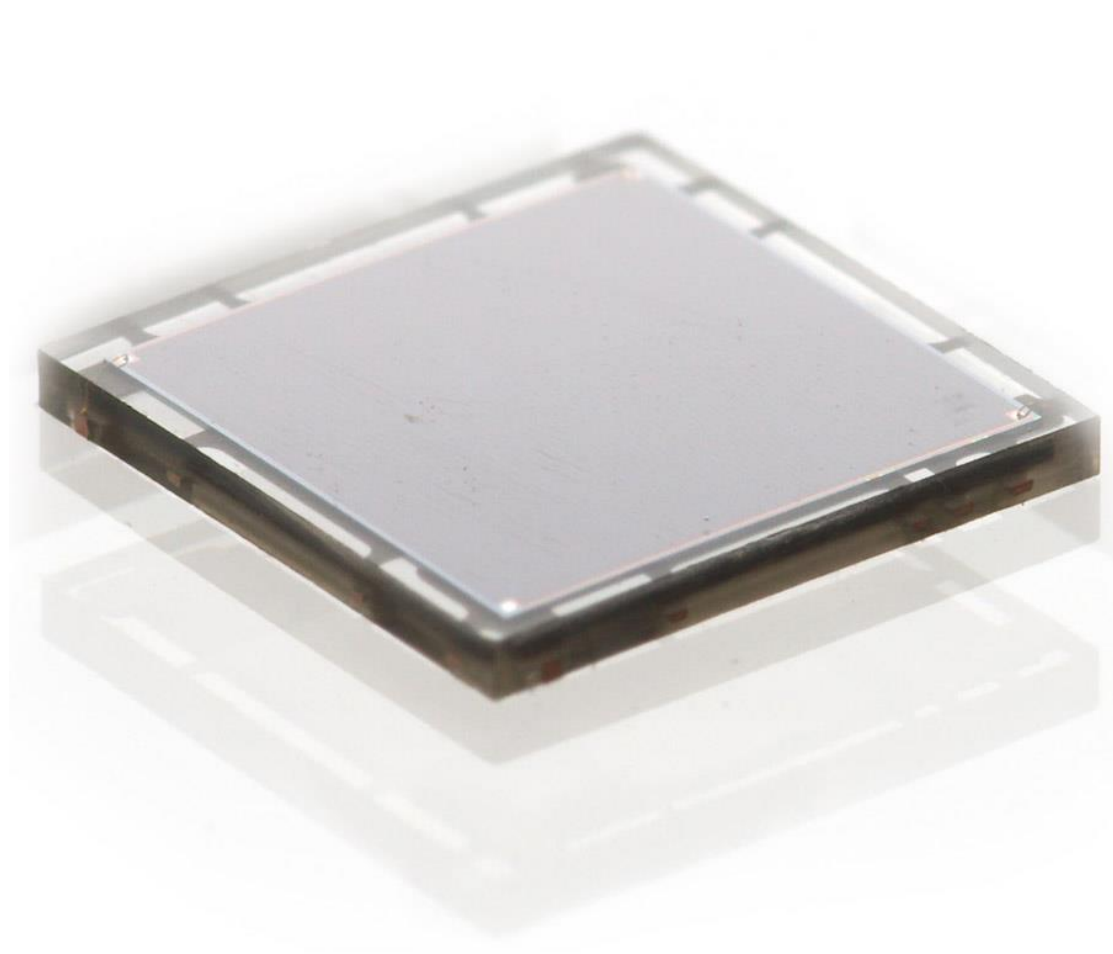

Fig. 2. Sensl semiconductor photo sensor

To install the sensor on a fibrous polished surface, a plastic fastener was made. Figures 3a and 3b show the appearance of a plastic fastener for a semiconductor photo sensor.

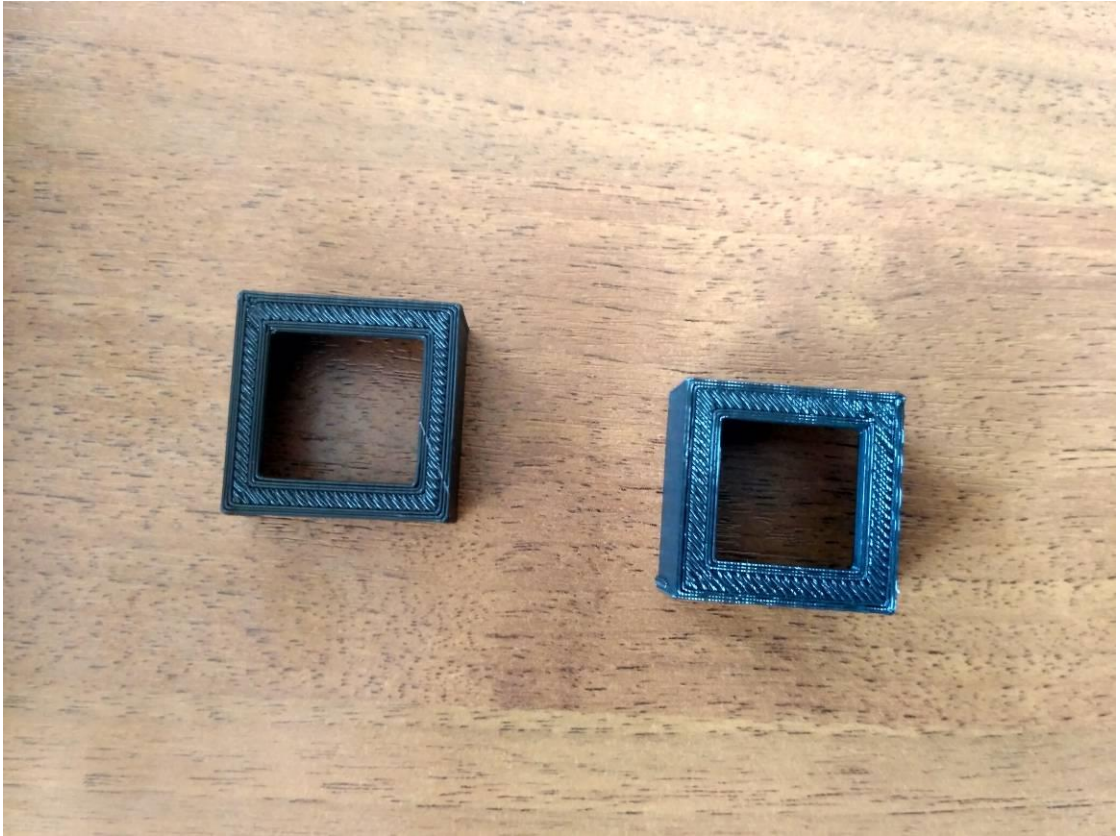

Fig. 3. plastic fastener for a semiconductor photo sensor.

A printed circuit board is provided for mounting the sensor. The sensor is a semiconductor element with BGA fastening to the printed circuit board. Altium Designer software was used to develop printed circuit boards. Figure 4a and 4b show a prototype of a printed circuit board in the Altium Designer software environment 17

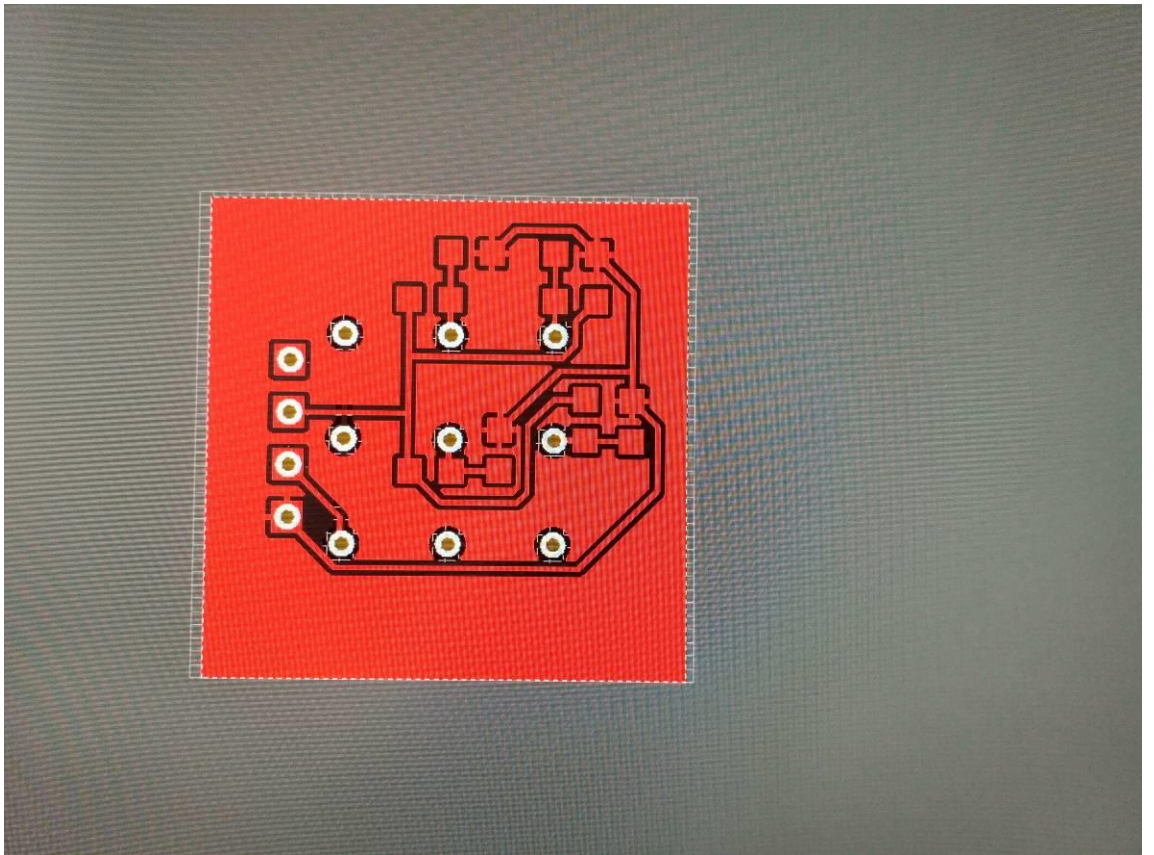

Fig. 4a. Prototype of a printed circuit board in the Altium Designer software environment 17, side a.

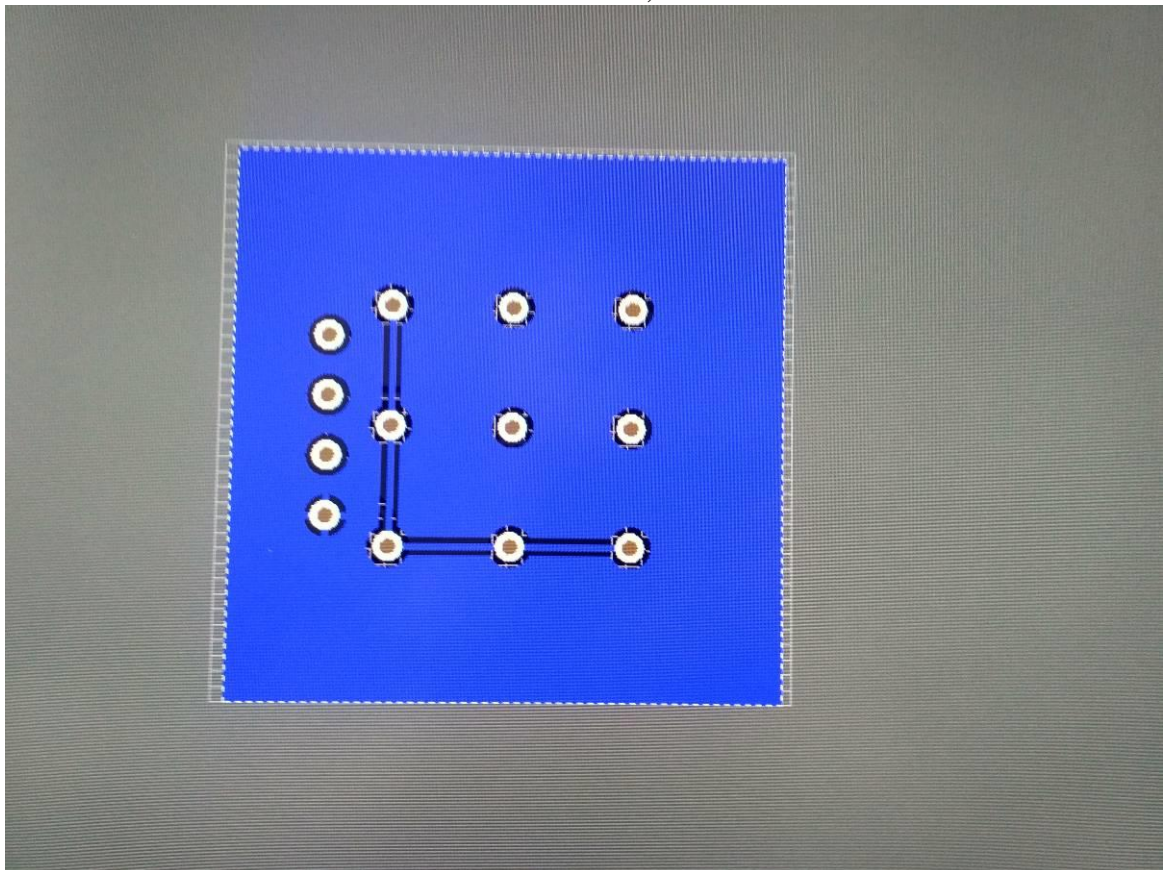

Fig. 4b. Prototype of a printed circuit board in the Altium Designer software environment 17, side b.

To connect a large number of sensors to the processing board, you need an adapter that feeds the sensor through the divider, and also removes the signal through a separating and smoothing capacitor. In Figures 5a and 5b, a prototype of the adapter circuit board for connecting to the board is presented, also executed in the Altium Designer software environment 17

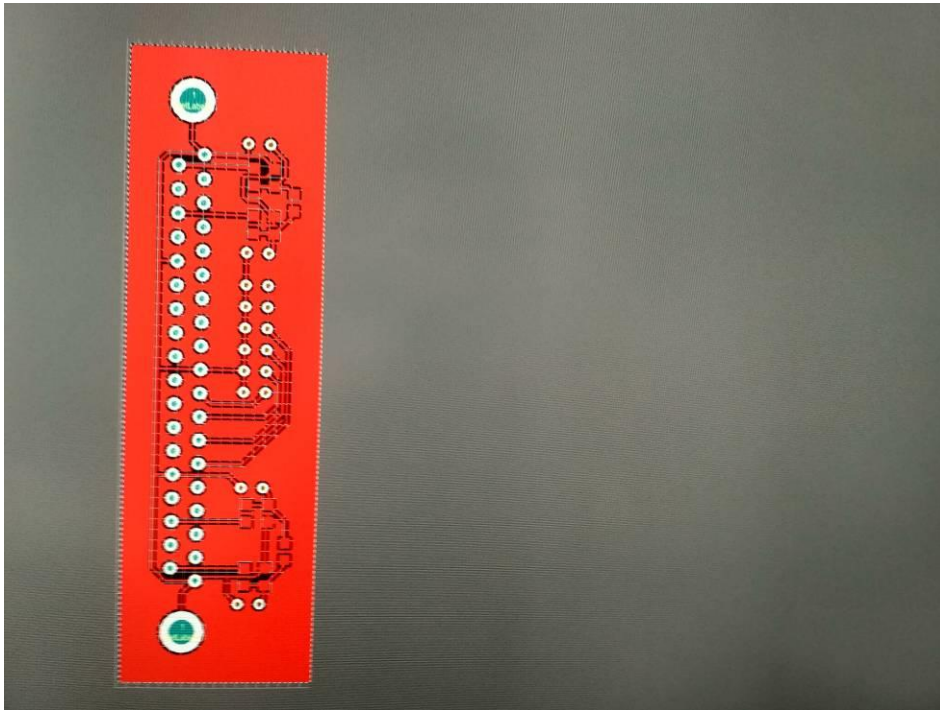

Fig. 5a. Prototype of a printed circuit board in the Altium Designer software environment 17, side a.

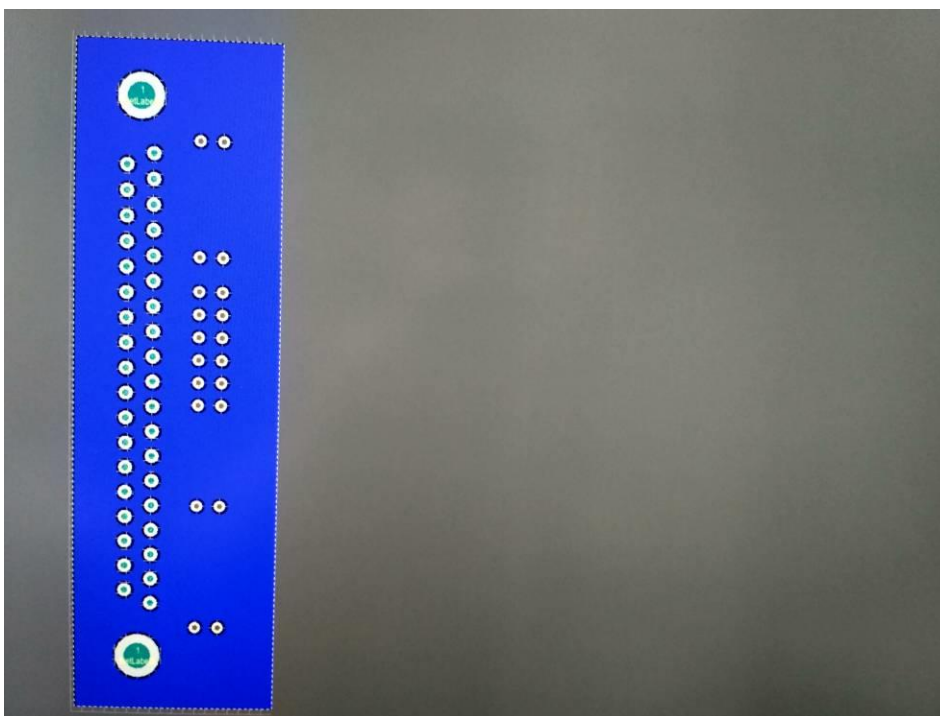

Fig. 5b. Prototype of a printed circuit board in the Altium Designer software environment 17, side b.

For serial production, these cards were combined into one file for transfer to production machines. This line-up allows to produce a large number of printed circuit boards for serial production of colorimeters for the needs of the NIKA project. Figure 6 shows the appearance of the prototypes of printed circuit boards prepared for transmission to serial machines.

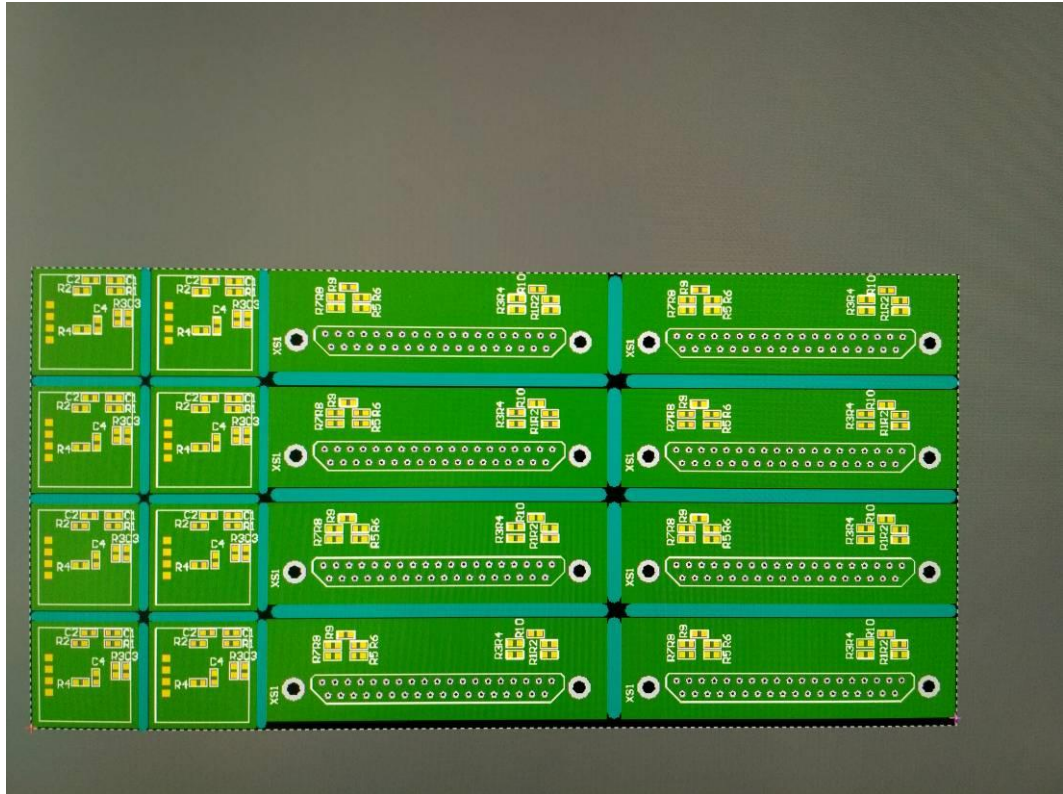

Fig. 6. Combined PCB into one file for transfer to production machines.

In addition to the extreme boards, there are side printed circuit boards. Figures 7a and 7b show the appearance of lateral longitudinal plates with semiconductor photodetectors.

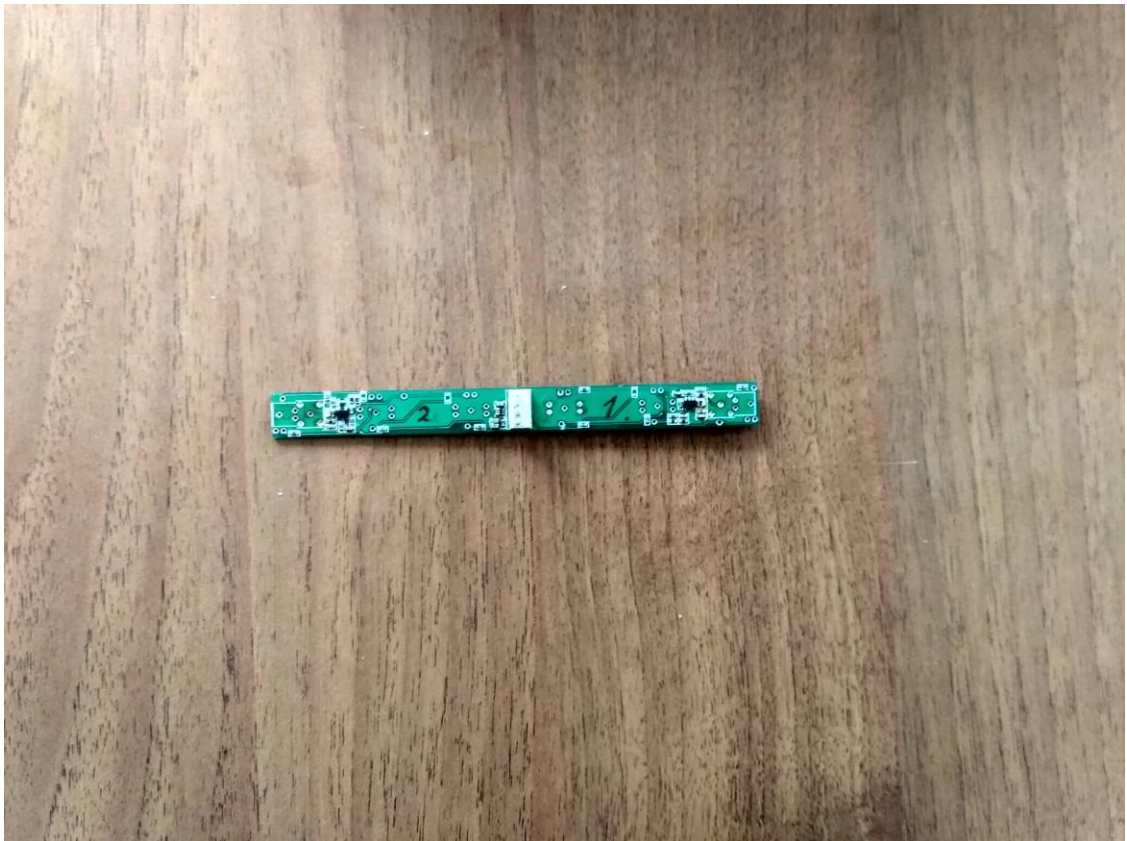

Fig. 7a. Lateral longitudinal plates with semiconductor photodetectors, side a.



Fig. 7b. Lateral longitudinal plates with semiconductor photodetectors, side b.

After the adapter card, the signal goes to the processing board. Figure 8a and 8b show the appearance of the signal processing board.

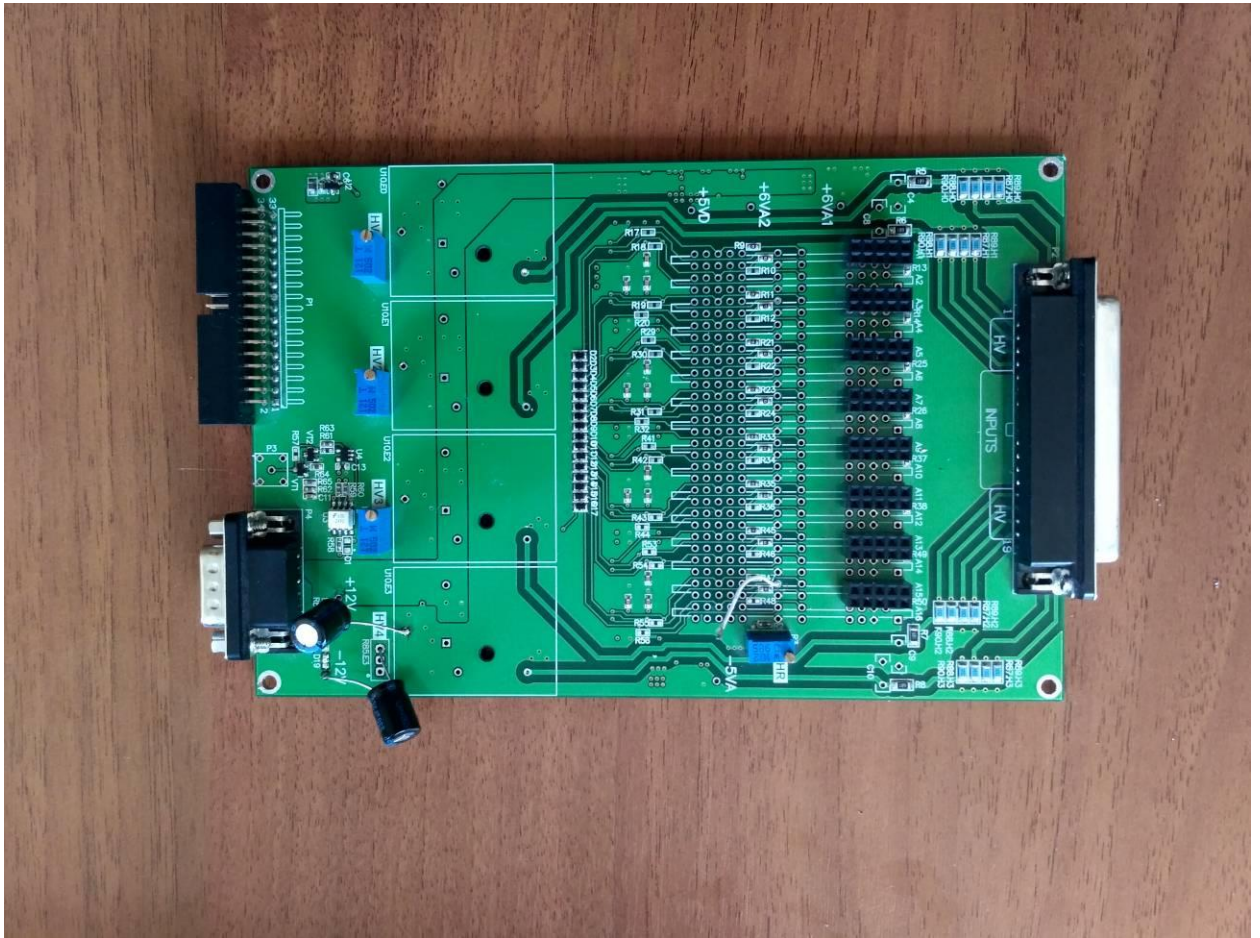

Fig. 8a. Signal processing board, side a.

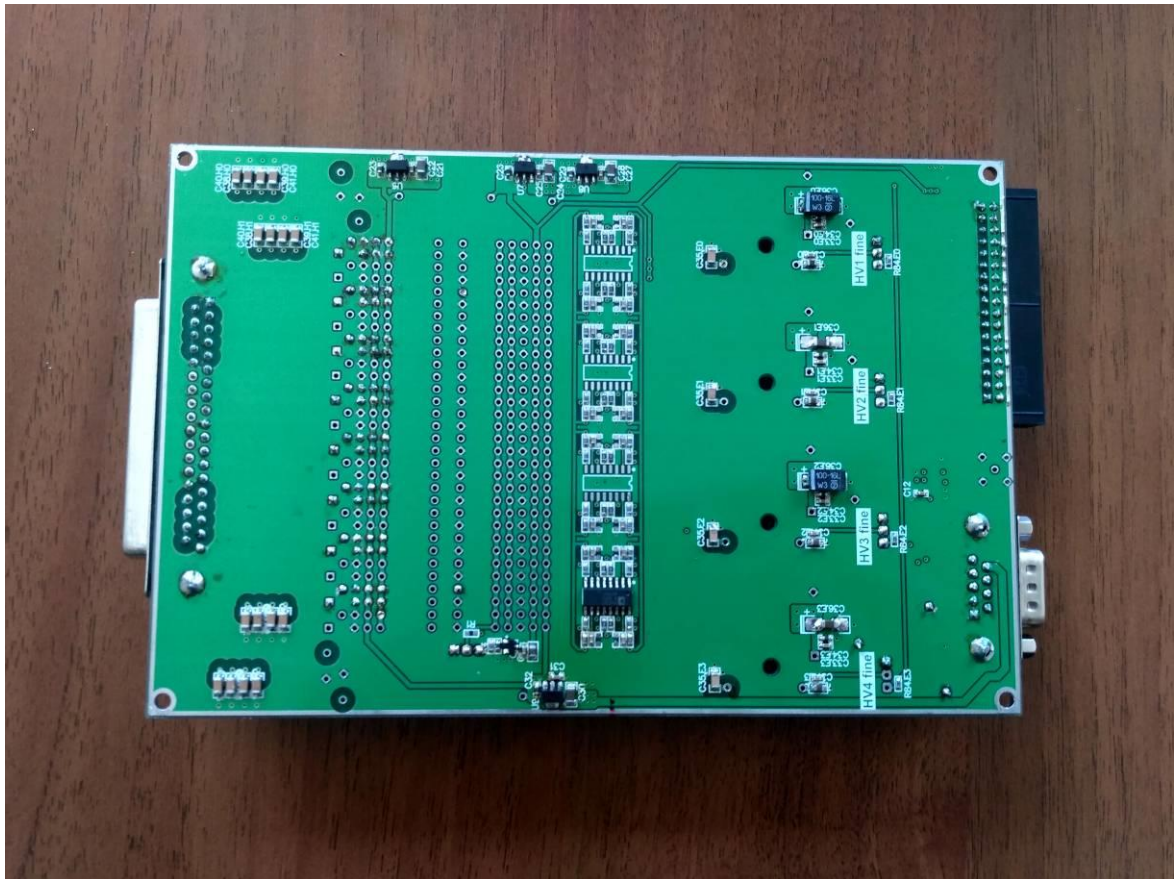

Fig. 8b. Signal processing board, side b.

The processing board uses submodules of amplifiers assembled on operational amplifiers AD8009. Figure 9a, 9b and 9c shows the appearance of the amplifier board.

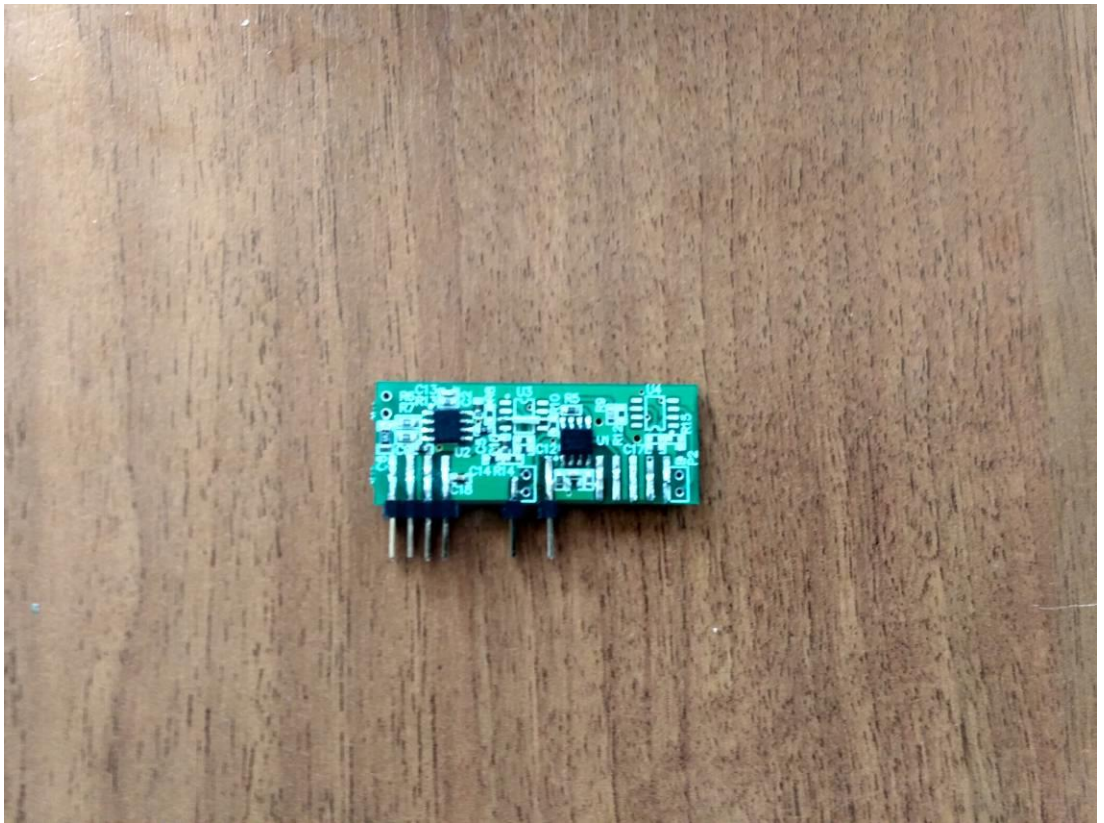

Fig. 9a. Amplifier board, side a.

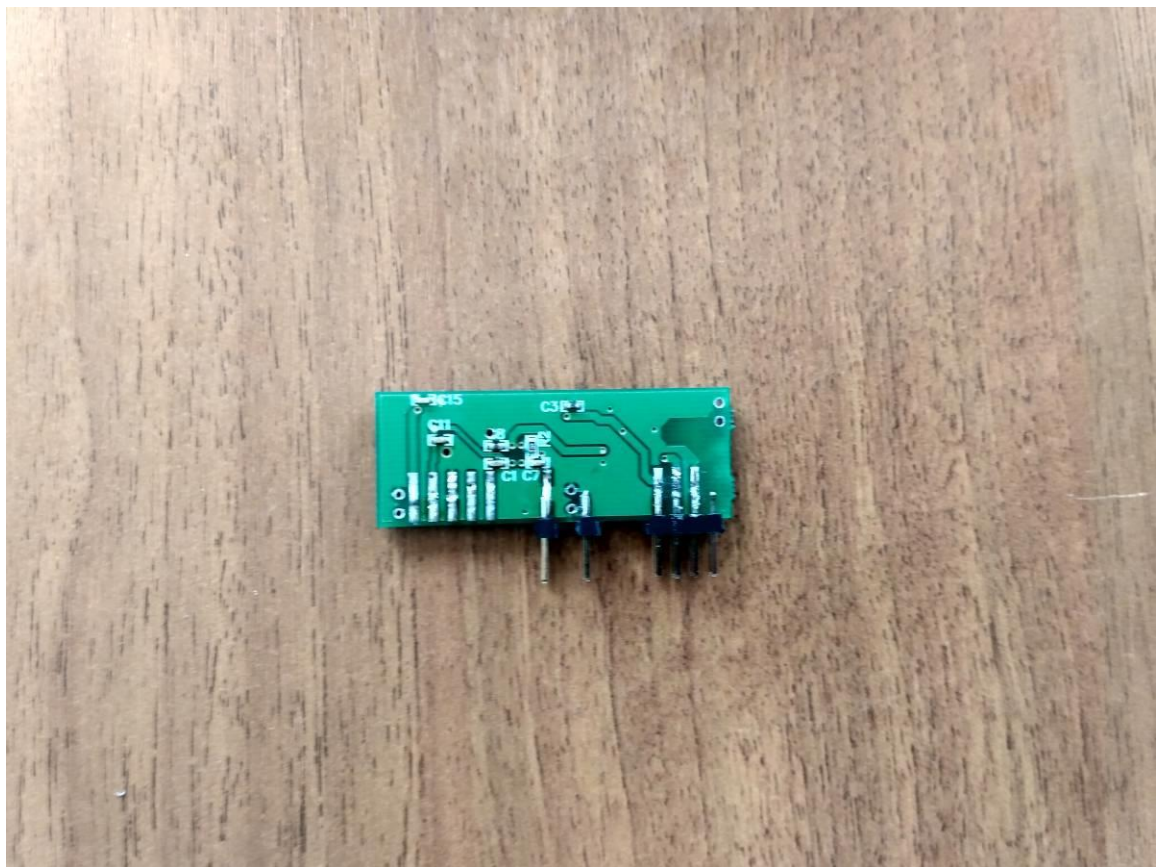

Fig. 9b. Amplifier board, side b.

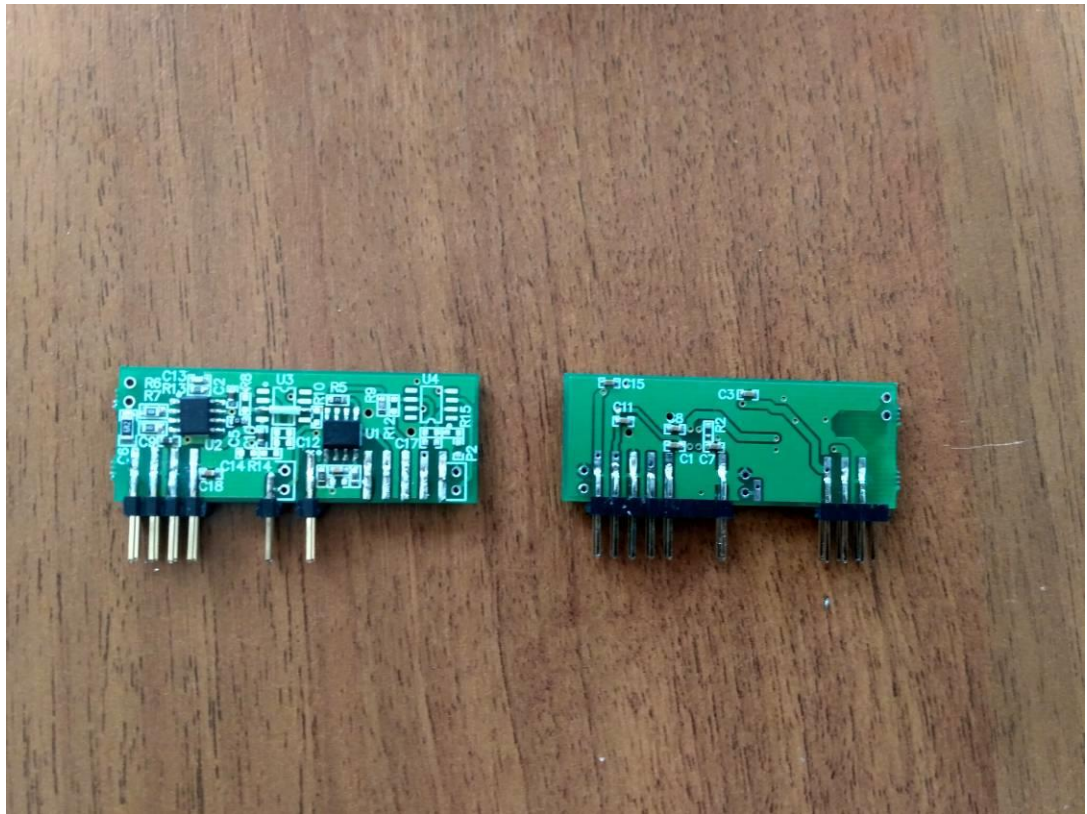

Fig. 9c. Amplifier boards.

The processing board is powered by a bipolar voltage of ± 12 Volts 0.1 A. Two boards are used for power supply of the board: 220 V mains and 5 V power supply. Figure 10a shows the appearance of the 220 V power supply unit, in Figure 10 b - the appearance boosting power supply 5 V.

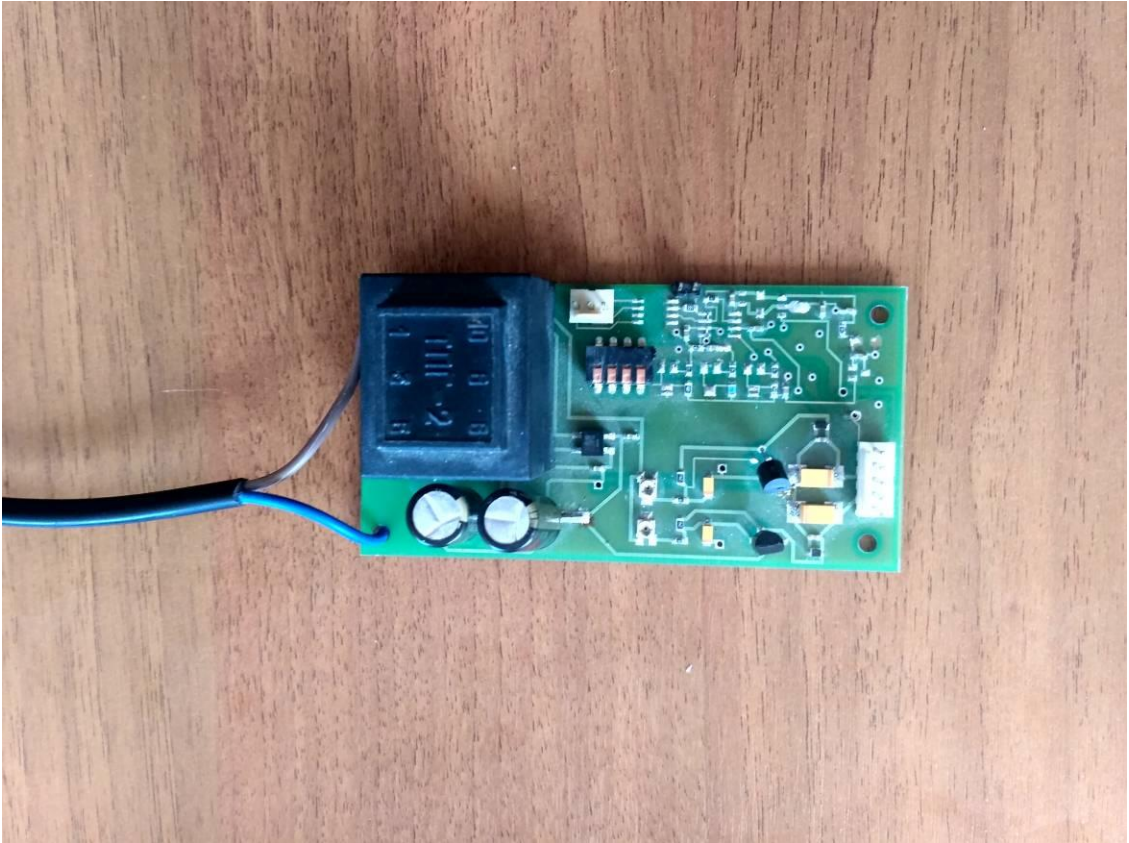

Fig. 10a. 220 V power supply unit.



Fig. 10b. Boosting power supply 5 V.

Conclusion

Results:

1. To power the module photoelectronic multiplier by The Photomultiplier ETEnterprises model 9141B, the existing 5 V incremental power supply for adjusting the negative supply arm was modified;
2. For measurement from the outer side fibers, the CMS Shashlik calorimeter prototype tower equipped with 25 aluminized WLS fibres Sensl semiconductor photodetectors has developed a sensor board;
3. For fixing to the extreme lateral fibers of Sensl photosensor, a plastic fastening element was developed;
4. To divide the supply voltage of the photosensor and to connect to the processing board, an adapter card was developed.

References

- [1] Shashlik Calorimetry. A combined Shashlik + Preshower detector for LHC, CERN LIBRARIES, Geneva, 1993, 72 p.
- [2] Claus Grupen, Boris Shwartz. Particle Detectors. Cambridge, 2nd ed, 2008, 651 p.
- [3] Darwin L. Wood and Kurt Nassau. Optical properties of gadolinium gallium garnet. APPLIED OPTICS/ Vol. 29, No. 25 , 1990, p. 3704 -3707.
- [4] В глубь материи: Физика XXI века глазами создателей экспериментального комплекса на Большом адронном коллайдере в Женеве. – М.; Этерна, 2009. – 576 с.: ил.
- [5] А. А. Загубский, Н. М. Цыганенко, А. П. Чернова. Детекторы излучения. Учебное пособие. Под ред. Рысь А. Г. Санкт-Петербургский государственный университет, С- Пб.; 2007, 68 с.

Acknowledgments

I express my deep gratitude for the help and advice in the work to Dunin Vladimir Borisovich, Kokoulina Elena Sergeevna (JINR), Karpova Elena for organization support and to other organizers of the summer student practice of JINR for a great time and useful experience. Thank you.