



JOINT INSTITUTE FOR NUCLEAR RESEARCH

Veksler and Baldin laboratory of High Energy Physics

FINAL REPORT ON THE SUMMER STUDENT PROGRAM

Superconducting Magnets for NICA Collider

Supervisor:

Dr. Sergey Alexandrovich Kostromin

Pr. en. Alexey Mikhaylovich Donagin

Students:

Alexey Bulygin

Valerya Mekhanikova

Maxim Trushin

NRNU MEPHI

Participation period:

July 01 – July 31

Dubna, 2016

CONTENTS

INTRODUCTION	1
MEASUREMENT METHOD.	4
The fluxmeter method	4
Induction coils	4
The flux measurement	4
Hall probe measurements	5
Magnetic resonance techniques	5
Fluxgate magnetometer.....	6
Visual field mapping	7
THE HARMONIC-COIL METHOD.....	7
VFC integrator and angular encoder	7
Servo Motor	8
Description of the harmonic method.....	9
Fourier analysis.	9
Math model.....	10
PRODUCTION OF MAGNETS	13
MULTIMETER.....	21
ACKNOWLEDGEMENT	22
REFERENCES	24

INTRODUCTION

Collider of protons and heavy particles of NICA is built at the nuclear center at Dubna. It helps to study quark–gluon plasma. The quark–gluon plasma is a special state of matter in which our Universe was after the Big Bang.

NICA includes two preliminary accelerators (Fig. 1). Nuclotron is main preliminary accelerator which was constructed in 1992. The second accelerator is booster synchrotron. Synchrophasotron was demounted and inside his ring of booster synchrotron will be built.

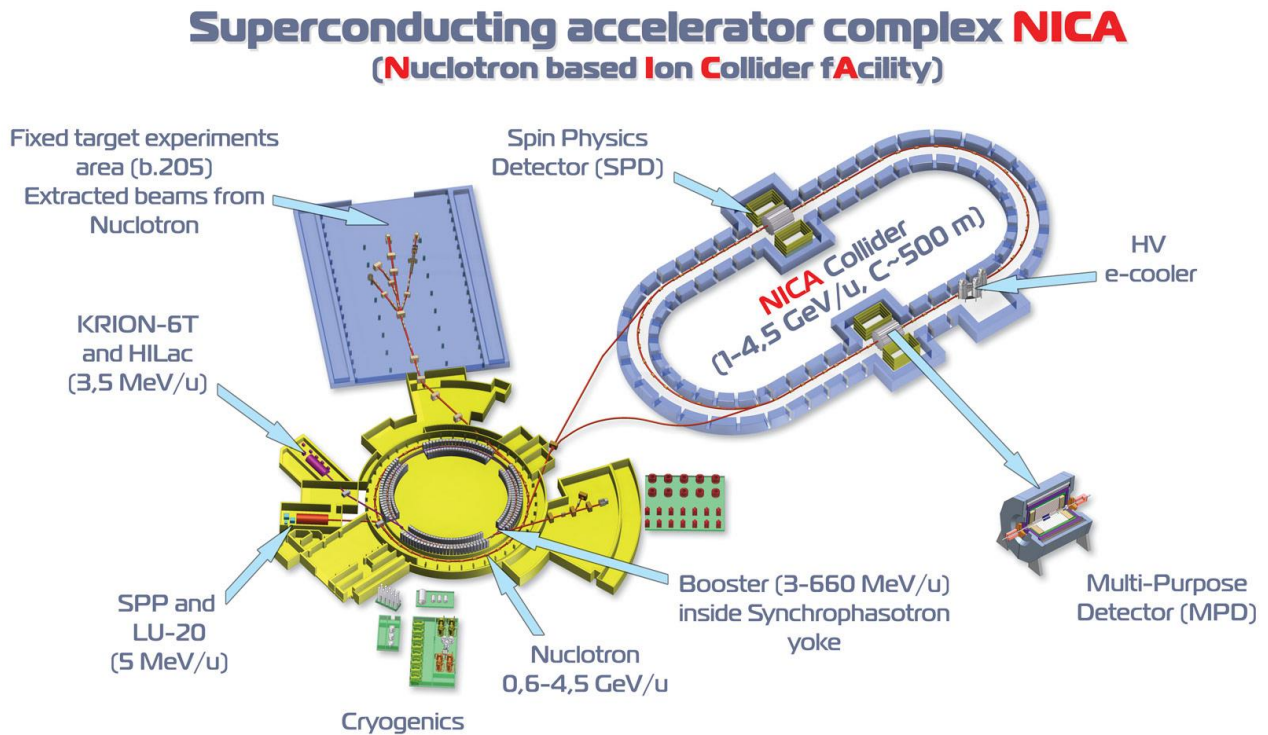

Fig. 1

In our scientific-experimental section of superconducting magnets are planned to collect devices - 40 dipole magnets for booster synchrotron (Fig. 4), 48 quadrupole magnets with multipole correctors for booster synchrotron (Fig. 3), 80 dipole magnets for NICA (Fig. 2), 86 quadrupole magnets with multipole correctors for NICA and 175 quadrupole magnets with multipole correctors for the synchrotron SIS100 (FAIR international project, Darmstadt).



Fig. 2 Dipole magnets for the NICA

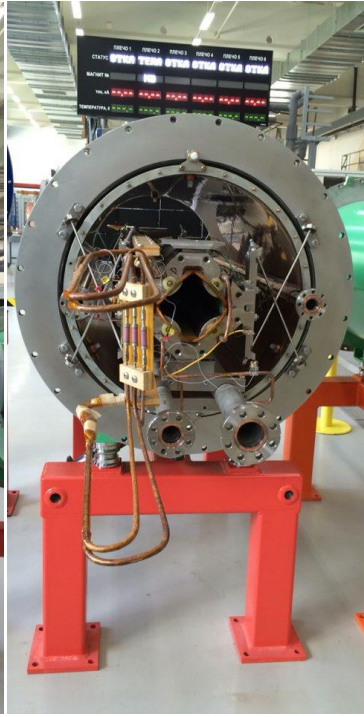

Fig. 3 Quadrupole magnets with multipole correctors for booster synchrotron

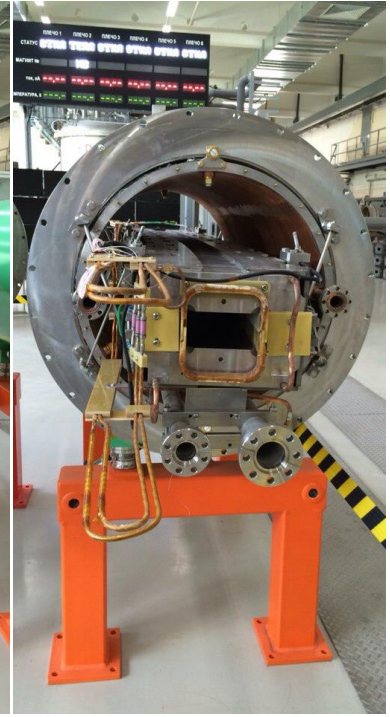

Fig. 4 Dipole magnets for booster synchrotron

Magnets for booster of NICA are curved (Fig. 5). Their radius of curvature is 14 meters and it is small enough. For instance, radius of curvature is 52 meters of dipole magnet for SIS100. It is more difficult to collect and test superconducting curved magnets than straight magnets. This problem was resolved when five frames were made. There are five short magnets instead of one full magnet. We will sum up all five magnets and will have the result for a single. If frames moved horizontally or frames were curved this system would be more difficult and more expensive.

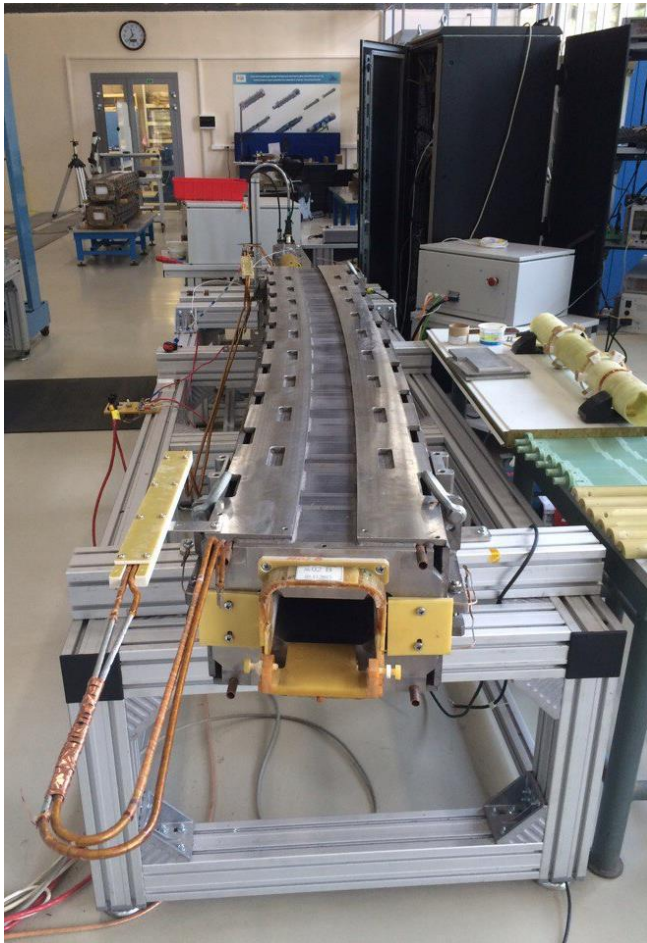

Fig.5 The magnet without the frame

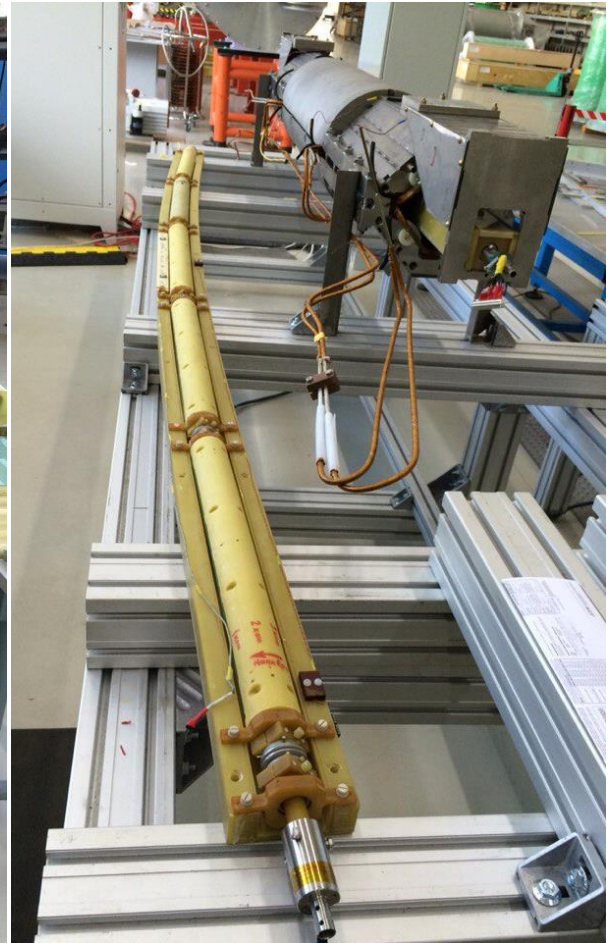

Fig.6. The frame outside the magnet

MEASUREMENT METHOD.

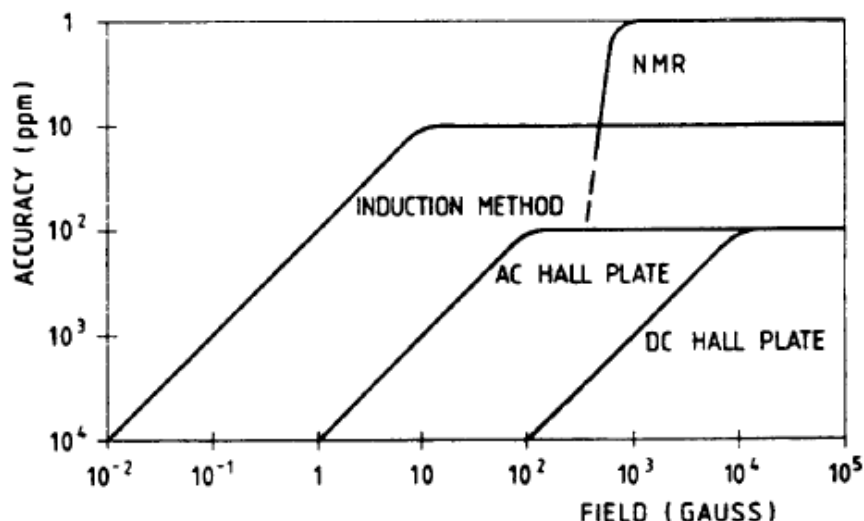

Fig.7 Measurement methods: accuracies and ranges

The fluxmeter method

This method is based on the induction law. It is the most important method for particle accelerator magnets and also the most precise method for measuring the direction of the magnetic flux lines. Measurements are performed either by using fixed coils in a dynamic magnetic field, or by moving the coils in a static field.

Induction coils

The coil method is particularly suited for measurements with long coils in beam-guidance magnets, where the precise measurement of the field integral along the particle trajectory is the main concern. The search coil is usually wound on a core made from a mechanically stable material, in order to ensure a constant coil area, and the wire is carefully glued to the core.

This method is very popular for use in magnets with circular cylindrical geometry. Harmonic coil measurements are the best choice for most types of accelerator magnets.

Advantages of search coil techniques are the possibility of a very flexible design of coil and high stability of the effective coil surface. Disadvantages are large induction coils and relatively slow measurements in static fields.

The flux measurement

The coil method was improved with the development of digital voltmeter and Miller integrator. Later in Cern was created new type of digital integrator, which is based on a high quality dc amplifier connected to a voltage-to-frequency converter (VFC) and a counter. Figure 8 shows an example of such an integrator.

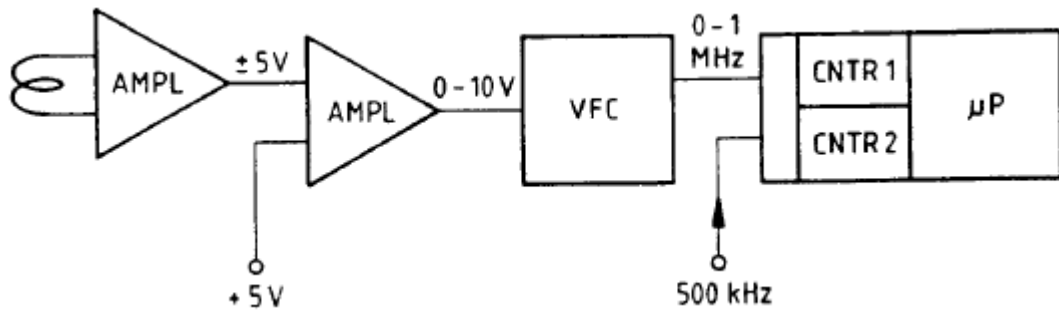

Fig.8 Digital integrator (Cern)

This system is well adapted to digital control but imposes limits on the rate of change of the flux since the input signal must never exceed the voltage level of the VFC.

Hall probe measurements

The Hall-generator provides an instant measurement, offers a compact probe, suitable for point measurements. The probes can be mounted on relatively light positioning gear. The wide dynamic range and the possibility of static operation are attractive features.

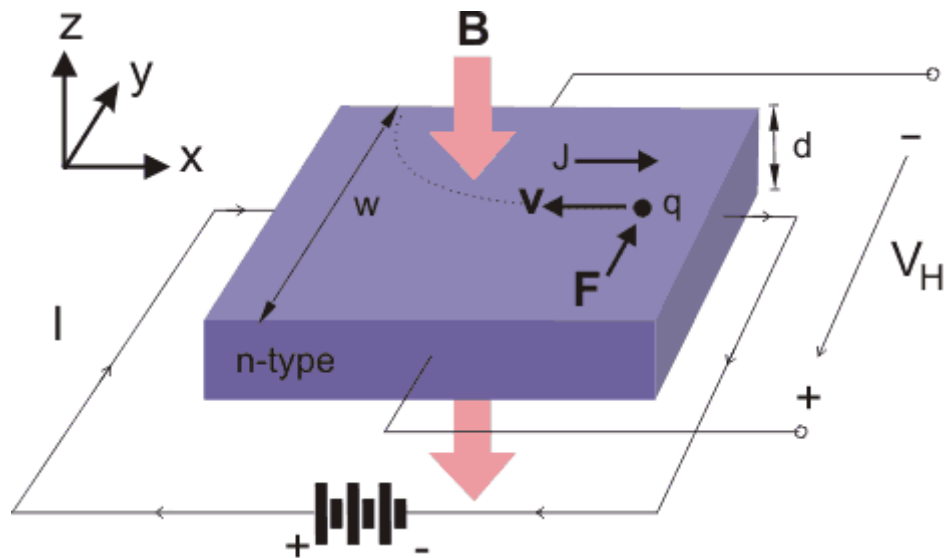

Fig. 9 Schematic diagram of the Hall effect.

The Hall generator of the cruciform type shows a better linearity and has a smaller active surface than the usual rectangular generator. The measurement of the Hall voltage sets a limit of about 20 μT on the sensitivity and resolution of the measurement, if conventional direct current excitation is applied to the probe. This is mainly caused by thermally induced voltages in cables and connectors.

Magnetic resonance techniques

The method has become the most important way of measuring magnetic fields with high precision. It is considered as a primary standard for calibration. Based on easy and precise frequency measurement it is independent of temperature variations.

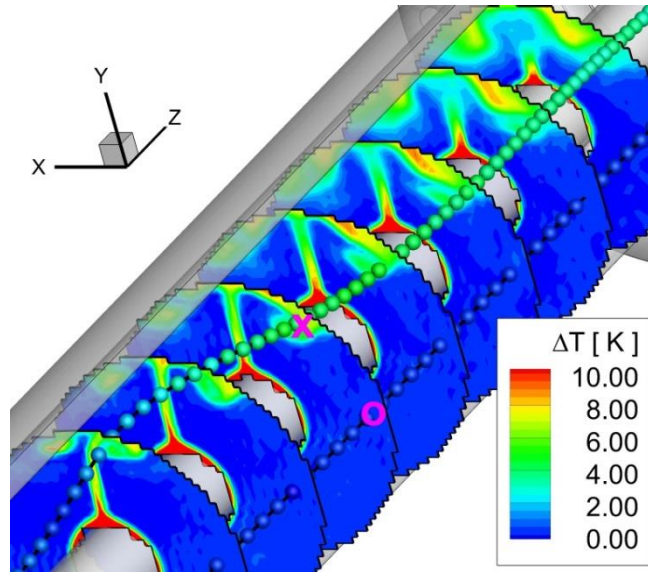

Fig. 10 Temperature difference field measured using the MRT technique.

The advantages of the method are its very high accuracy, its linearity and the static operation of the system. The most important disadvantage is the need for a rather homogeneous field in order to obtain a sufficiently coherent signal.

Magnetic resonance imaging (MRI) has been proposed for accelerator magnet measurements.

Fluxgate magnetometer

The fluxgate magnetometer is based on a ferromagnetic core on which detection and excitation coils are wound. The core is made up from a fine wire of Mumetal or a similar material than has an almost rectangular hysteresis curve. The method is restricted to use with low fields, but has the advantage of offering a linear measurement and is well suited for static operation. Also it is suitable for studies of weak stray fields around accelerator or detector magnets.

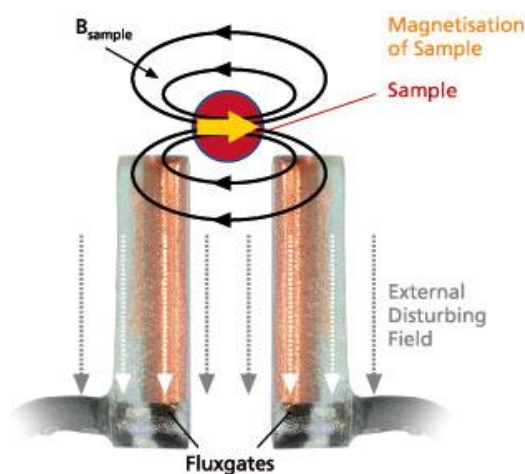

Fig. 11 Fluxgate-Magnetometer

Visual field mapping

Visual field mapper is made by spreading iron powder on a horizontal surface placed near a magnetic source, thus providing a simple picture of the distribution of flux lines.

THE HARMONIC-COIL METHOD.

This method requires careful and extensive design and fabrication. The harmonic coil method is simply a generalization of the above development to measure the phase and amplitude of any harmonic component of the field. The resulting accuracy is estimated for different designs commonly in use in devices based on the harmonic-coil method.

The main problem is achievement a full two-dimensional measurement of the field in a cylindrical aperture.

VFC integrator and angular encoder

Let's talk about integrator and schematic diagram of a harmonic coil system. Figure 12 shows design using a multitrack absolute encoder.

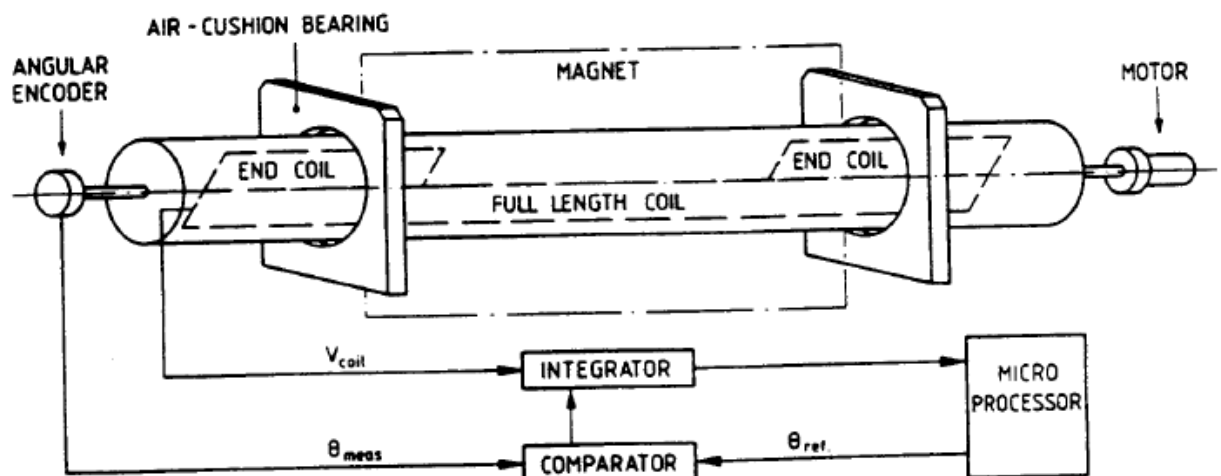

Fig. 12 Schematic diagram of a harmonic coil system.

The set of coils is mounted on a cylindrical frame which is longer than the magnet to be measured. The comparator triggers the integrator at angular positions measured by a multitrack absolute encoder.

Description:

1. The processor controlling the measurement feeds the comparator with the next angle of the measurement.
2. Once the encoder reaches that position, the integrator receives a trigger than latches the content of the counters for reading and resets them zero.

3. A pair of counters is used on integrators so that one is counting whilst the order is read by the processor then reset to zero.
4. The trigger from the encoder has just to change the direction of the output of the VFC from one counter to the other.
5. One full turn of the measuring coil takes typically from 1 to 60 seconds.

Servo Motor



Fig. 13 Kollmorgen AKM Series Servo Motor

The angle positions were given by stepping motors (Fig. 13) or by mechanical wheels with teeth to attain high precision, while early harmonic coil systems had to rotate stepwise between consecutive angular positions to allow the reading and reset of the integrator on each angular position.

Following the data acquisition, a computer sums up the contributions of the incremental integrated voltages, performs the Fourier analysis, and then divides each term obtained by the corresponding geometrical sensitivity of the coil.

The current supply of the magnet must be extremely reproducible to obtain a reasonable precision.

The measuring sequences become:

1. Reset the integrator with no current in the magnet
2. Go to specified current and read the integrator

3. Reset the integrator and integrator and integrate when the current goes back to zero to allow drift cancellation by averaging with the previous measurement
4. Go to the next angular position

Description of the harmonic method.

The use of a voltage integrator connected to the measuring coil makes it possible to eliminate the time coordinate in the induction law of Faraday. The voltage integrator read as a function of the angle gives directly the flux from the zero angle where it is reset.

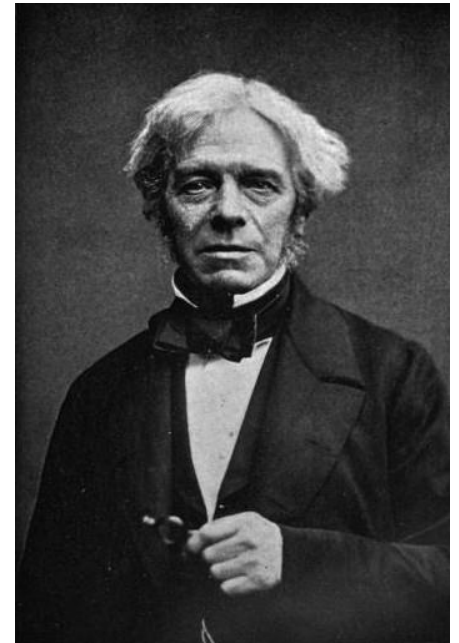
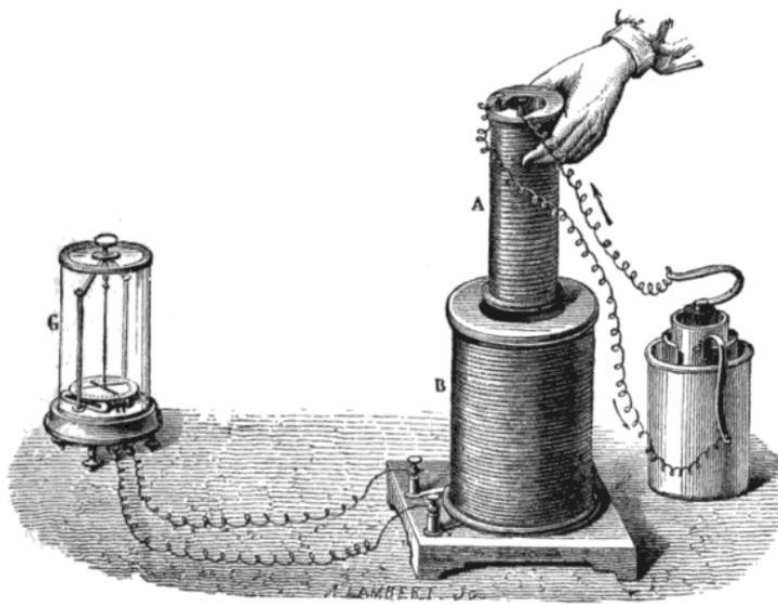

Fig. 14 Faraday and his induction experiment.

The length of the measuring coil follows a compromise between, on the other hand, the mechanical stability of the frame holding the coils and the ease of winding these, and of the other hand a too large number of longitudinal positions needed to measure the whole magnet.

The definition of the harmonic number used in this report, $n = 1$ for the dipole, $n = 2$ for quadrupole, etc., implies that the sensitivity is proportional to the rotation radii to the power of the harmonic order considered, and that the angular dependence of the flux is proportional to the order.

The harmonic coil method is most suitable for small and cylindrical apertures.

Fourier analysis.

The system has to make a Fourier analysis of the flux curve, after some treatment of the raw data collected. For this purpose a Fast Fourier Transform (FFT) algorithm is used. Since the function is periodic and the result is a Fourier series it is simpler to choose an encoder having 2^N points per turn.

A full three-dimensional analysis shows that a flux integrated over the length of the rotating coil represents the integrated field or harmonic if the axial component of the field is zero over the two end faces of the coil. The ends are measured separately from the integral of the field over the full magnet.

A Fourier analysis of the measured curve thus gives a description of the parameters of the field: amplitudes of harmonics of the field, coordinates of the displacement or resulting dipole component.

The main contribution to sum of the incremental integrated voltages is equal to the drift of the integrator over the time needed for full turn.

Math model

Magnetic field has cylindrical symmetry with respect to the axis OZ. In this case components of magnetic induction have a look:

$$B_r(\theta) = \sum_{n=1}^{\infty} \left[\left(\frac{r}{R_{ref}} \right)^{n-1} (a_n \cos n\theta + b_n \sin n\theta) \right] \quad (1)$$

$$B_\theta(\theta) = \sum_{n=1}^{\infty} \left[\left(\frac{r}{R_{ref}} \right)^{n-1} (-a_n \sin n\theta + b_n \cos n\theta) \right] \quad (2)$$

Frame rotates along an axis OZ on radius R_1 and R_2 . It has length L_{coil} and numbers of coils w . It's needed to find coefficients a_n and b_n .

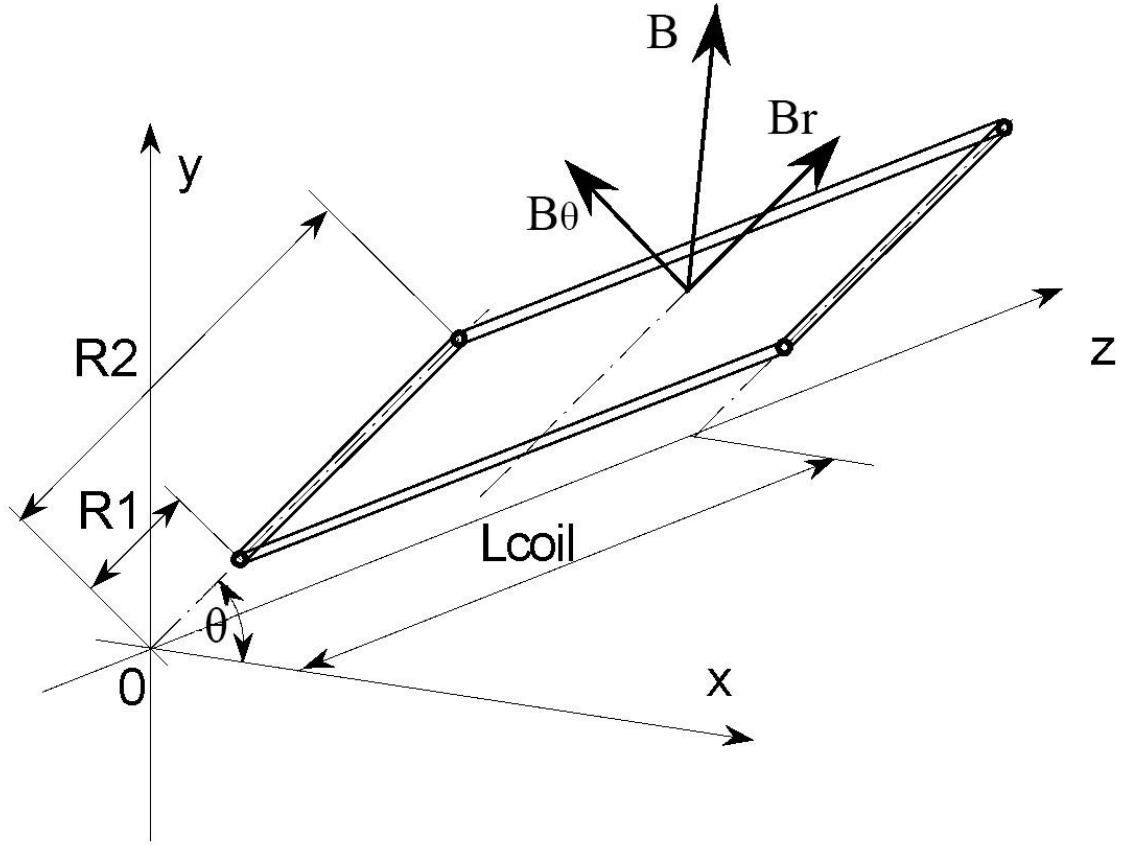

Fig. 15 A coil for measurements of magnetic field

The magnetic flux associated with the coil:

$$\Phi(\theta) = L_{coil}W \int_{R_1}^{R_2} \left[\sum_{n=1}^{\infty} \left(\frac{r}{R_{ref}} \right)^{n-1} (-a_n \cos n\theta + b_n \sin n\theta) \right] dr \quad (3)$$

The *integral* of a function $\Phi(\theta)$ over the *interval* $[R_1, R_2]$ is equal:

$$\Phi(\theta) = L_{coil}W \sum_{n=1}^{\infty} \left[\frac{R_{ref}}{n} \left\{ \left(\frac{R_2}{R_{ref}} \right)^n - \left(\frac{R_1}{R_{ref}} \right)^n \right\} (-a_n \cos n\theta + b_n \sin n\theta) \right] \quad (4)$$

The relationship between integrated voltage for different angles θ and magnetic flux is:

$$\Phi(\theta) = \int U(t) dt \quad (5)$$

Fourier series representation of a function $\Phi(\theta)$:

$$\Phi(\theta) = \int U(t) dt = \sum_{n=1}^{\infty} (A_n \cos n\theta + B_n \sin n\theta) \quad (6)$$

Since from (4) and (6):

$$a_n = -A_n \frac{n}{L_{coil} w R_{ref} \left(\left(\frac{R_2}{R_{ref}} \right)^n - \left(\frac{R_1}{R_{ref}} \right)^n \right)} = -A_n \frac{1}{S_n}, \quad (7)$$

$$b_n = B_n \frac{n}{L_{coil} w R_{ref} \left(\left(\frac{R_2}{R_{ref}} \right)^n - \left(\frac{R_1}{R_{ref}} \right)^n \right)} = B_n \frac{1}{S_n} \quad (8)$$

S_n – “area” of coil for harmonic number n .

Real coils consist of windings which are distributed in space. In this case it's needed to calculate other integral of magnetic flux.

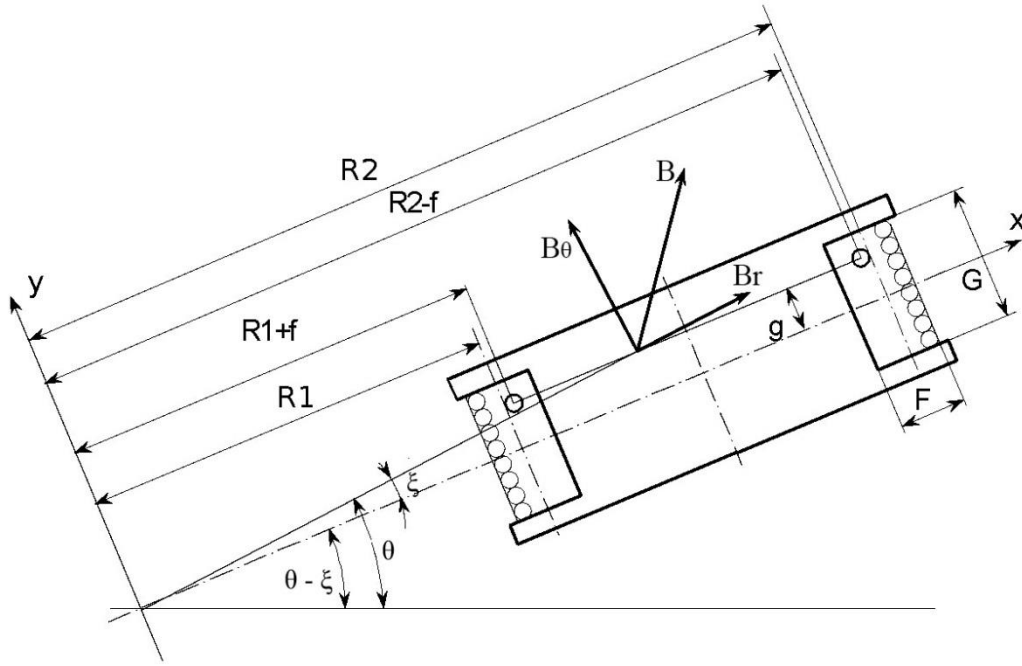

Fig. 16 A coil consist of windings which are distributed in space

Projection of a vector B onto an axis y:

$$B_y = B_r \sin \xi + B_\theta \cos \xi \quad (9)$$

Fourier series representation of a function B_r and B_θ , and equation (9) gives:

$$B_y = \sum_{n=1}^{\infty} \left[\left(\frac{r}{R_{ref}} \right)^{n-1} (\cos n\theta \{b_n \sin(n-1)\xi - a_n \cos(n-1)\xi\} + \right. \\ \left. + \sin n\theta \{a_n \sin(n-1)\xi + b_n \cos(n-1)\xi\}) \right] \quad (10)$$

The magnetic flux is:

$$\Phi = \frac{W}{FG} L_{coil} \int_{-\frac{F}{2}}^{\frac{F}{2}} \int_{-\frac{G}{2}}^{\frac{G}{2}} \int_{R_1+f}^{R_2-f} B_y df dg dx \quad (11)$$

From figure 16:

$$r = \sqrt{x^2 + g^2} \quad (12)$$

$$\xi = \tan^{-1} \left(\frac{g}{x} \right) \quad (13)$$

The result can be generalized:

$$\Phi = \frac{W}{FG} L_{coil} \sum_{n=1}^{\infty} (-a_n \cos n\theta + b_n \sin n\theta) \times \int_{-\frac{F}{2}}^{\frac{F}{2}} \int_{-\frac{G}{2}}^{\frac{G}{2}} \int_{R_1+f}^{R_2-f} \left(\frac{\sqrt{x^2 + g^2}}{R_{ref}} \right)^{n-1} \cos \left((n-1) \tan^{-1} \left(\frac{g}{x} \right) \right) df dg dx \quad (14)$$

A similar relationship ((6) and (7)) holds for frame:

$$S_n = \frac{W}{FG} L_{coil} \int_{-\frac{F}{2}}^{\frac{F}{2}} \int_{-\frac{G}{2}}^{\frac{G}{2}} \int_{R_1+f}^{R_2-f} \left(\frac{\sqrt{x^2 + g^2}}{R_{ref}} \right)^{n-1} \cos \left((n-1) \tan^{-1} \left(\frac{g}{x} \right) \right) df dg dx \quad (15)$$

PRODUCTION OF MAGNETS

The assembly of magnets has several stages as any difficult process. .

The first stage is production metal part of the magnet according to a drawing at Savelovsky machine works.

Theorists from accelerator division set parameters for the magnet and engineers begin to work on the whole construction etc. And then, this is coordinated to technologists. Engineers and technologists work together and appreciate an ability to

build one type of the magnet. When the magnet is at the division, engineers check accuracy of all dimensions and control all parameters.

It does in parallel with superconducting windings. This process includes a few stages. Superconductor is wound on tube at first.

The superconductor may be wound outside the magnet and it is cooled outside. Superconductor under our technology is wound on a tube, and it is cooled by inside supply of liquid helium. Insulating braid applies on top the superconductor and form is made for quadrupole or dipole lens in a further. There is deference, because it is needed to create four poles for quadrupole lens and two poles for dipole.



Superconductor is inspected by characteristics - geometry internal resistance, inductance. All parameters must have technical specification.

It is controlled on two stands, because each type of a magnet has own mounting and locking system. One stand is for dipole magnet and another one for quadrupole.

When all careful tests a yoke and a winding is done, magnet is built. And then, engineers make warm measurements for defect detection connected to materials or an assembly.



Fig. 17. The stand for quadrupole magnet

The magnet is checked by step motor (Fig. 18). Its important function is ability to turn at needed angle. A motor by means of coupler rotates frame and sets require



angle. One step is $\frac{1}{64}$ of a turn. The motor is specifies, but it is needed tracking system with feedback. An encoder (type of sensor) shows real angle of rotation. This whole system helps to calculate mechanical errors

in bearings and couplers. Also, it sets precise angle and analyze an ability of the motor to do a full rotation.

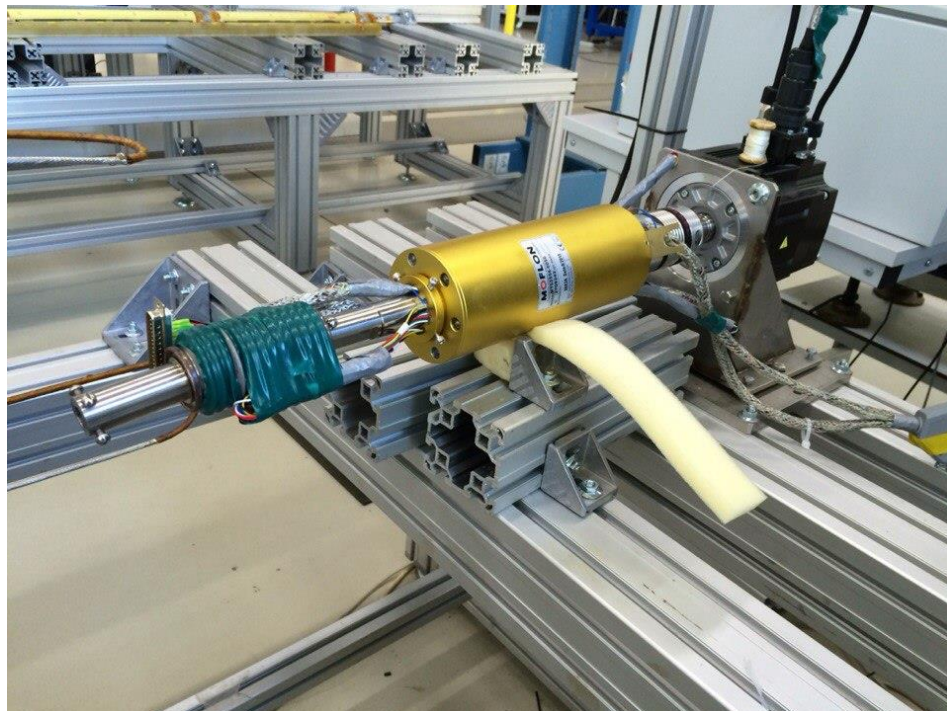

Fig. 18. The step motor and the slip ring”

The next stage is preparing magnet for cold measurement, it means supply of liquid helium in the superconductor. Constructors from cryogenic division develop special wiring diagrams for this. They need for proper operation of the magnet during the check. For example, radius of a tube must be certain size; it needs to mount necessary details without problems.

The magnet is mounted in special cryostat (Fig. 19). It contains nitrogen shield which is needed to avoid too much temperature difference. Constructors solve layout problems. They create comfortable position for a work with the tubes with liquid helium and develop technology for docking modules to each other.

The liquid helium supply system is turn on first for cooling the magnet.

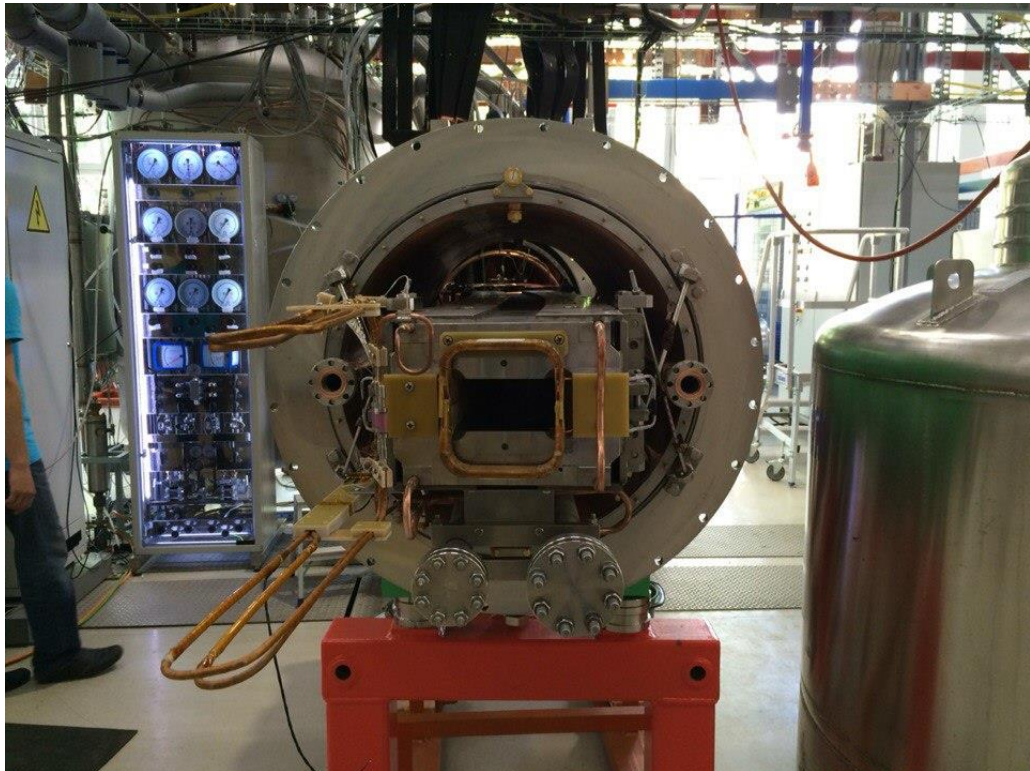

Fig. 19. The cryostat for cold measurements of magnets

The magnet then goes to a testing. The current injection cryostat is multipurpose. It can be connecting with quadrupole and dipole magnet. The current is let by the current injection cryostat (fig.20). It gives opportunity to connect the whole cooling system.

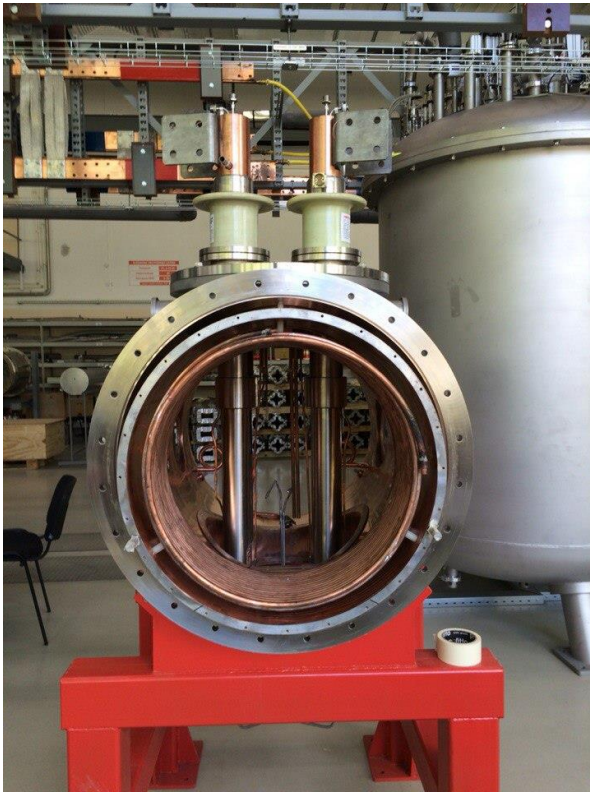

Fig. 20. Current leads cryostat



Fig.21. current leads the cryostat from the inside



Fig. 22. Extracted from the cryostat current leads



A deformation appears, then system begin cool. Consequently, there is compensating device. The system cools gradually to a working temperature ($t_{He}^{\circ} = 4,2 \text{ K}$). When the magnet is cooled, engineers cannot demount it immediately.

If they let wet air, temperature will change rapidly and snow “coat” will appear.

When the magnet is verified with liquid helium, a vacuum must be in the cryostat. For this process, diffusion pumps use in the system

Cold measurements are conditions which completely repeat working conditions in the accelerator. The magnet will be demounted if it works well and shows all needed parameters without failures. The next magnet will be installed after that. This process takes one and a half week.

Within this month we have seen as single magnet completely passed all stages. At the end of practice one more magnet has gone on cold measurements.



Fig. 23. The current source

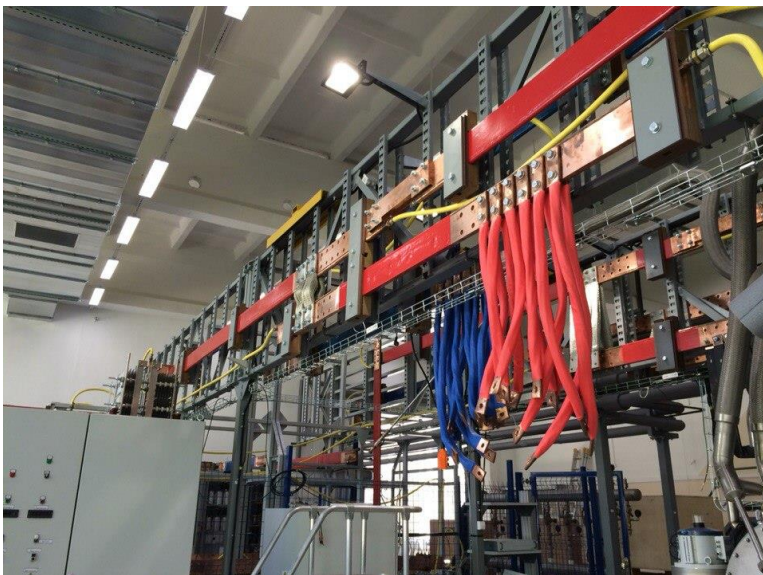
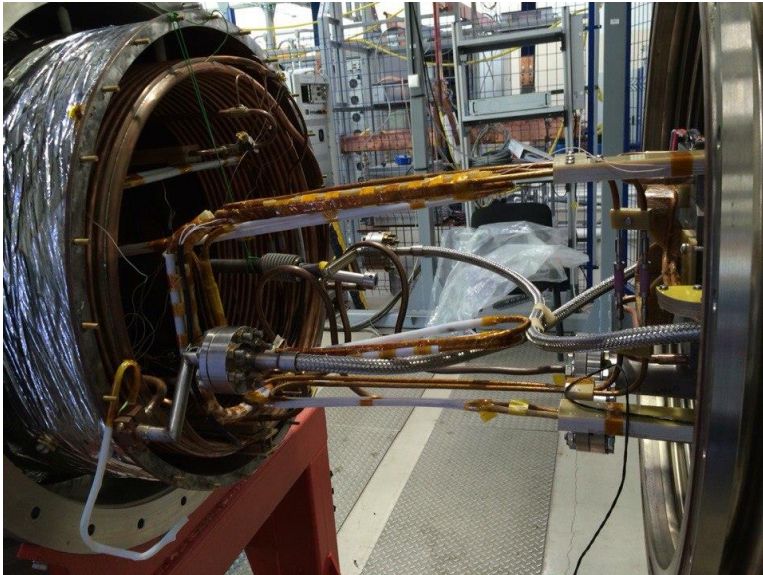

MULTIMETER

In our laboratory we worked with a lot of precise and high-quality modern devices. We want to tell you about one of them in detail. This is high-performance digital multimeter 34465A. It takes high resolution, fine accuracy and significant measurement speed.



Engineers use this millimeter to visualize measurements for different purposes. It helps to take needed information faster and simplifies recording results.

Digital millimeter 34465A has huge graphic capabilities such as trend graphs and histograms. It gives engineers totally understanding current process.

This device has a huge memory, it is 2 000 000 measurements. New measurements stored instead the oldest measurements then memory is full. It can measure very low current (range of 1 μ A with picosecond resolution) and we can measure very low-power devices.

It helps to measure DC voltage, AC voltage, DC, AC, temperature, capacitive reactance, the continuity, the frequency, the period and properties of a diode.

With it you can measure DC voltage, AC voltage, AC and DC currents, temperature, capacitance, continuity, frequency and period and to test the diode.

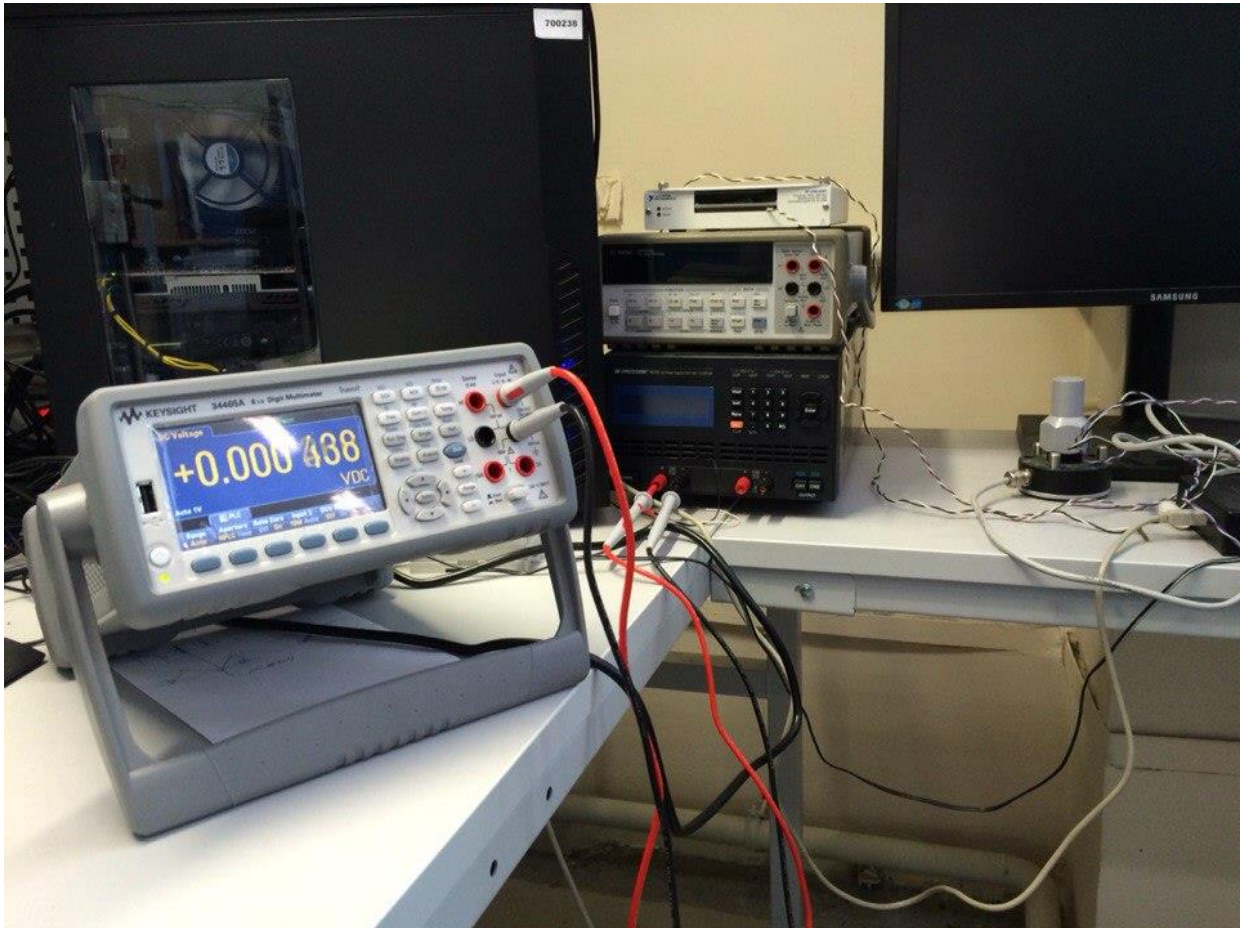

The multimeter Keysight 34465A has function access files. It gives standard connection with a computer by USB port. Also, it has the import data feature, which allows configuring parameters of the device and transmits the screen shot in computer's program without any additional applications.

The BenchVue software allows you to manage digital multimeters Keysight at the same time with other table devices Keysight without any additional applications. Engineers can instantly transmit data files in a computer by USB, LAN and GPIB without analysis.

Real signals have never been clean. They often have variable component from a supply network or another noise (electromagnetic interference etc.). Digital multimeter deals to this external influence and eliminates their impact on result. Consequently, it

gives high accuracy. Engineers can be sure in their measurements thanks to patented technology of analog-to-digital conversion of multimeters Keysight Truevolt. This technology accounts errors of typical source of the interference.

ACKNOWLEDGEMENT

We would like to express our appreciation to Dr. Sergey Alexandrovich Kostromin and Pr. en. Alexey Mikhaylovich Donagin, our practice supervisors for giving us an opportunity to participate in Student Summer Program 2016.

We also wish to acknowledge the help provided by Shandov M.M. for consulting us in our work.

REFERENCES

- [1] S.Turner, Magnetic measurement and alignment, Geneva, 1992.
- [2] S.Turner, Measurement and alignment of accelerator and detector magnets, Geneva, 1998.
- [3] <http://madx.web.cern.ch/madx/>

List of electronics.

We told you about the multimeter, but also we worked with a lot of other devices. There is list of a large part of devices in our laboratory.

- 1) Digital Multimeter Agilent 3458A
 - 2) Digital Multimeter Agilent 34401A
 - 3) Programmable DC Power Supplies BK precision 9151
 - 4) Dual Range DC Power Supplies BK precision 9173
 - 5) Power Supplies GW instek GPS-72303 and GPR-76060d
 - 6) Power supply Danfysik System 8500
 - 7) Direct Drive Rotary Motors Kollmorgen Housed DDR dh061m-22-1310
 - 8) Nanovoltmeter Keithley 2182a
 - 9) Waveform generator Keysight 33600A
 - 10) Digital Multimeter Keysight 34465A
 - 11) Universal Frequency Counter Timer Keysight 53230A 350 MHz
 - 12) DC Current Source Keithley 6221
 - 13) Direct Drive Rotary Motors Kollmorgen akm53g
 - 14) Motor Mitsubishi hf-sp1024B
 - 15) Gaussmeter Lake Shore Model 475
 - 16) Power supply PS 260
 - 17) LCR Bridge/Meter Rohde & Schwarz HM8118
 - 18) Oscilloscope Tektronix dpo 3014
 - 19) Oscilloscope Tektronix tds 3014
 - 20) Oscilloscope Tektronix tds 3032
 - 21) Multifunction Calibrator Fluke 5720A
 - 22) Transconductance Amplifier Fluke 52120A
- and a lot of electronics from National Instrument...