



JOINT INSTITUTE FOR NUCLEAR RESEARCH
Frank Laboratory of Neutron Physics

FINAL REPORT ON THE SUMMER STUDENT PROGRAM

INVESTIGATION OF MATERIALS OF NEUTRON GUIDES AT THE IBR-2 REACTOR

Supervisor:

Dr. Maksim Victorovich Bulavin

Student:

Akhmedov Yakub
Abdumalikovich, Uzbekistan,
Institute of Nuclear Physics

Participation period:

August 19 – October 11

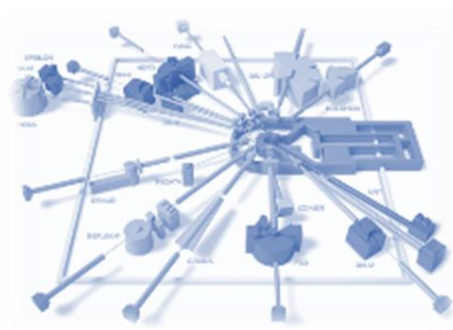

Dubna, 2018

CONTENTS

1. Literature analysis.....	3
1.1 IBR-2	3
1.2 Irradiation facility.....	8
2. Properties of neutrons.....	9
2.1 History of neutron scattering.	9
2.2 Neutron sources.	10
2.3 Properties of neutrons.	11
2.4 Neutron Guides and Mirrors	12
3. Experiment.....	14
3.1 Experimental methods and techniques	14
3.2 Neutron energy spectrum and flux densities in channel No. 3.....	16
3.3 The space distribution of the neutron flux density.....	18
3.4 Neutron fluencies and absorbed doses during irradiation at IBR-2	18
4. Results and consultations	19
4.1 Results of neutron guide glasses irradiation.....	19
4.2 Conclusions and suggestions	20
5. Acknowledgement	21
6. References.....	22

1. LITERATURE ANALYSIS

1.1 IBR-2

The IBR-2 reactor, operating at the Frank Laboratory of Neutron Physics of Joint Institute for Nuclear Research, Russian Federation, is a fast-pulsed reactor. Practically, all of the neutron beams of the IBR-2 reactor are applied for the study of structure and properties of materials by time-of-flight neutron scattering method. The beam №3 is an exception which is used for carrying out experiments in neutron irradiation of various materials, as well as for the study of their radiation resistance. Experiments in the irradiation of materials are carried out in the framework of FLNP JINR cooperation with such mega science projects as LHC (the detectors ATLAS and CMS) and TOKAMAK (the projects ITER and DEMO), as well as in the framework of cooperation with scientific organizations of JINR member-states, Russia and all over the world. A wide range of materials under study on the irradiation facility of the IBR-2 reactor includes the research of radiation resistance of printed circuit boards and other elements of detectors, sensors of the magnetic field, GaAs scintillators, new perspective materials for neutron guide glasses, radiation coloring of topazes and other semiprecious stones, production of medical radioisotopes of molybdenum, technetium, iodine, platinum and others in a broad sense of neutron flux density from $5 \cdot 10^5$ n/cm²·s to $2 \cdot 10^{12}$ n/cm²·s in the range of their energy from 25 meV to 10 MeV. The current paper gives a brief overview of experiments, results and their discussion.

IBR-2 is a pulsed research nuclear reactor with compact active core [3]. The core of the reactor is an irregular hexahedron composed of fuel element subassemblies. There are 7 fuel elements (plutonium dioxide) in each subassembly. The cooling system has three circuits and two loops. In the first and second circuits the coolant is liquid sodium and in the third it is air. The core is installed in a double-walled steel vessel and is surrounded by a number of stationary reflectors, control and safety among them. Around the reactor are water moderators which are scanned by 14 horizontal channels for neutron extraction. Two of the moderators are grooved (Fig. 1). The power pulses at 5 Hz are generated by reactivity modulators: the main moveable reflector (MMR) and the auxiliary moveable reflector (AMR).

When they both approach the core a power pulse develops. For a pulse repetition frequency of 25 Hz the AMR is slowed down [2].

The IBR-2 research fast neutron reactor (JINR, Dubna) has been put into operation in 1984 and shut down in 2006 for modernization because of the expiration of his service life. In this

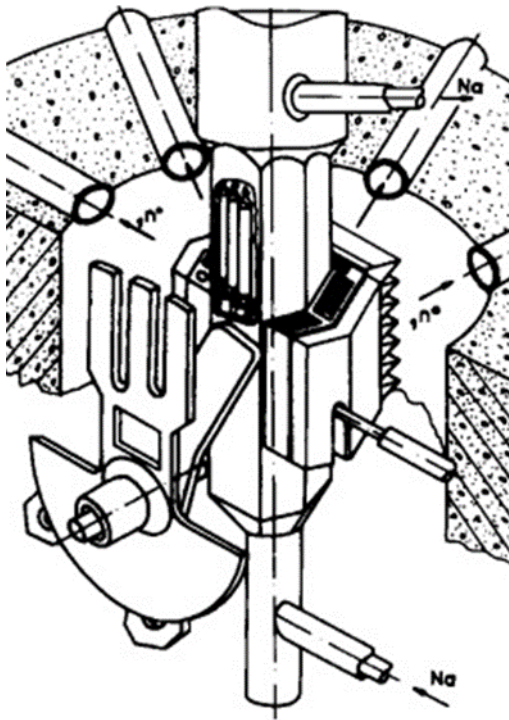

Fig. 1. A schematic view of principal IBR-2 parts. Shown are the main and auxiliary reflectors, one of the control reflectors, core, water moderators, sodium cooling system and horizontal neutron beams.

years (Fig. 2) [1].

connection the main equipment (vessel, drivers and movable operating units of the control and safety system) and fuel loadings of the reactor were replaced. The biological shield, reactivity modulator and technological system remained the same [1].

The parameters before and after the modernization are given in Table 1. The reactor provides activation with thermal, epithermal and fast neutrons for analytic purposes [4].

The loading of IBR-2 took 14 months (from 17.12.2010 until 14.02.2011) and the rated power of 2MW was achieved at 12.10.2011. The critical loading of the modernized reactor is 64 fuel assemblies. The remaining uncharged cells will ensure the reactor service life for no less than 20

Table 1. The IBR-2 reactor parameters before and after the modernization.

Parameter	IBR-2 before modernization	IBR-2 after modernization
Average power, MW	2	2
Fuel type	PuO ₂	PuO ₂
Number of fuel assemblies	78	69
Maximum bum-up, %	6,5	9
Pulse frequency, Hz	5; 25	5; 10
Pulse half-width, ps	215	200
Rotation rate, rev/min:		
main reactivity modulator	1500	600
auxiliary reactivity modulator	300	300
Material of main and auxiliary reactivity modulators	steel	nickel
Moveable reflector life, hr	20000	50000
Number of satellites at 5 Hz	4	1
Coolant	Sodium	Sodium
Sodium flow rate through the core, nr/hr.	80-110	80-110

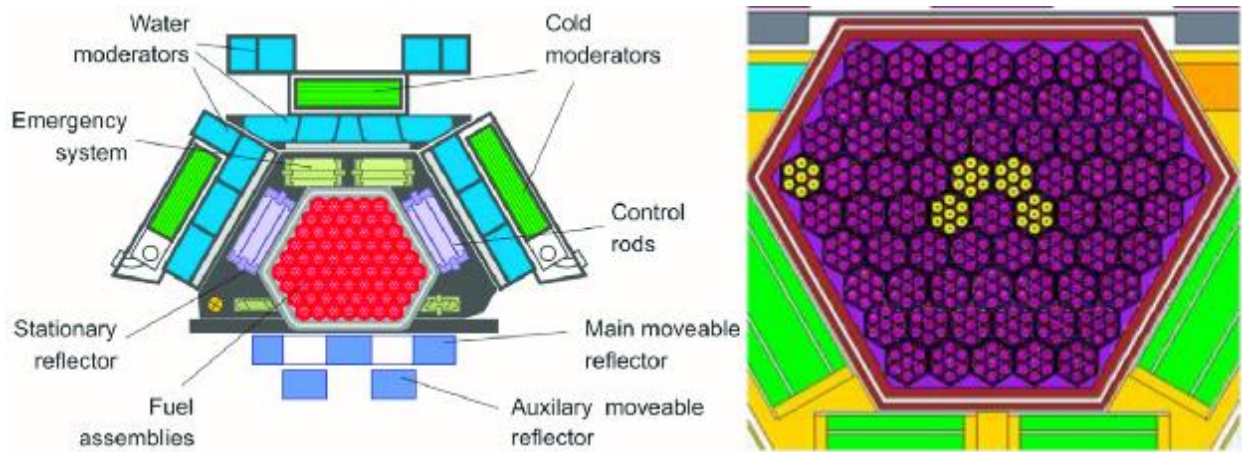

Fig. 2. Final core loading pattern of the IBR-2 modernized reactor with 64 fuel assemblies.

Two safety system units are intended for fast emergency power cutback. In 0.1s each of them reduces reactivity by 0.12%, which reliably brings the reactor below prompt criticality and suppresses neutron generation. The response of the reactor to external reactivity perturbations due to a change in the operation mode or failure of various technological systems that ensure normal functioning of the reactor has been studied. All main reactivity effects are negative. As the power increases, various power feedback effect components start to develop. Numerous experiments in the power range from 500 to 2MW and at a sodium flow rate through the core from 60 to 100m³/h have

demonstrated that power, flow rate and temperature effects are negative. The power pulse

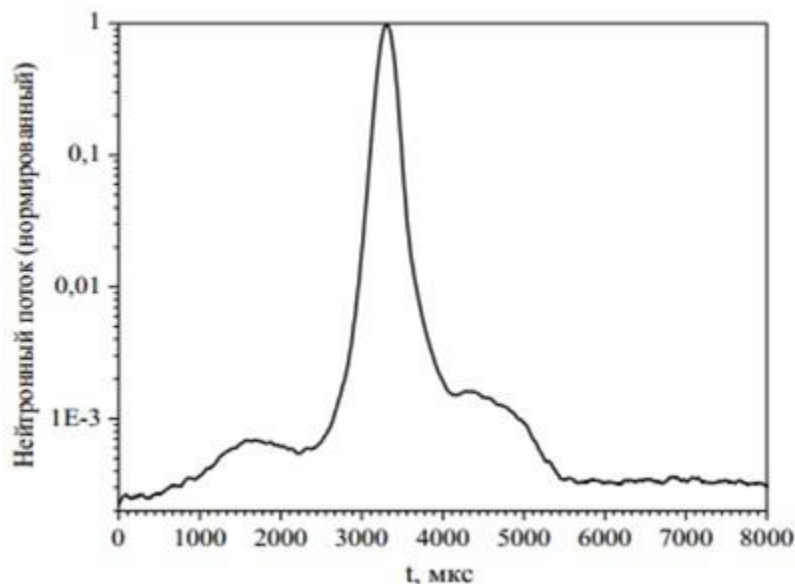

Fig. 3. IBR-2 power pulse shape. The data is normalized to the pulse maximum.

shape is the most important characteristic of IBR-2M both for the reactor personnel and the neutron beam users in neutron time-of-flight experiments. The IBR-2 pulse shape is close to a truncated Gaussian distribution with half-width and half-maximum of $200 \pm 4 \mu\text{s}$ (Fig. 3) [1].

A distinctive feature of IBR-2 as compared with steady-state reactors is a high sensitivity of IBR-2 to external reactivity fluctuations: about 40 times higher than that of steady-state reactors with uranium fuel. A normal operation of IBR-2 requires minimization of all reactivity noise sources [1].

The investigations have shown that the main source of pulse energy fluctuations are axial (towards the core) vibrations of the blades of the movable reflectors. Other effects, for instance, fluctuation of the temperature and flow rate of sodium passing through the core in a turbulent flow manifest themselves to a much lesser degree and their influence on the fluctuations on power may be neglected [1]. Table 2 presents some nuclear-physical parameters of IBR-2 characterizing the reactor both as a nuclear physical facility and a pulsed neutron source.

Table 2. The IBR-2 nuclear-physical characteristics.

Parameter	Parameter notation	Value
Half-width at half-maximum	$\theta_{1/2}, \mu\text{s}$	200 ± 4
Pulse power	W, MW	1830
Power in background (between pulses)	W_b, MW	0.2
	$W_b, \%W_{\text{avcr}}$	8.6
Average peak fast neutron flux density in safety system	$\Phi_f, \text{n}/(\text{cm}^2/\text{s})$	$2.26 \cdot 10^{17}$
Average thermal neutron flux density on grooved water moderator surface	$\Phi_t, \text{n}/(\text{cm}^2/\text{s})$	$\sim 10^{13}$

In order to conduct experiments at IBR-2 on neutron activation analysis and radiation studies there are: a pneumatic system 'Regata,' channel 11 (for multipurpose studies), several experimental sites with 3 hot chambers to irradiate samples for material studies [2]. Table 3 shows the analytic investigations that have been done at IBR-2 reactor through the years:

The IBR-2 reactor is equipped with a unique complex of neutron spectrometers, allowing a wide range of interdisciplinary research in the field of condensed matter physics, materials science, chemistry, biology, geophysics, pharmacology, medicine, nuclear physics, ecology, etc. The IBR-2 reactor shutdown period was actively used for work on the creation of new and modernization of existing facilities. At present, 18 units are in operation at the reactor or are in the final stage of development, of which 14 are used for research in the field of condensed matter, 2 - in the field of nuclear physics, 1 - radiation material science and 1 - neutron activation analysis.

Table 3. Analytic investigations at IBR-2 reactor.

Instrumental neutron activation analysis Conventional INAA	Epithermal neutron activation analysis ENAA	Cyclic neutron activation analysis CNAA
Environmental Studies		Material Science
<ul style="list-style-type: none"> Air pollution studies (air filters) Biomonitoring atmospheric depositions (moss, lichens) Assessment of the environmental situations (waste dumps, oil accidents, aquatic pollution (Moscow Sea, Oka River Basin, Lake Baikal)) 		<ul style="list-style-type: none"> High purity materials (aluminum, semiconductors - silicon, germanium, gallium arsenide) Biotechnologies: (I) biochemical leaching of elements by aerobic and anaerobic bacteria; (II) Se- containing pharmaceuticals based on blue-green algae <i>Spirulina Platensis</i> Construction materials in the problem of decommissioning of nuclear power plants

Spectrometers used for the study of condensed matter currently include 7 diffractometers, 3 reflectometers, 1 small-angle scattering spectrometer, 2 inelastic neutron scattering spectrometers, 1 spectrometer for neutron radiography and tomography. The predominance of diffractometers is to some extent due to historical reasons, as well as to a number of objective factors - the development of a new unique Fourier diffraction technique that permits diffraction experiments with very high resolution (up to $\Delta d/d \sim 0.1-0.2\%$) and the wide possibilities of using diffraction techniques in interdisciplinary scientific research - from the physics of the condensed state to biophysics, geophysics and medicine.

The layout of the facilities in the IBR-2 experimental hall

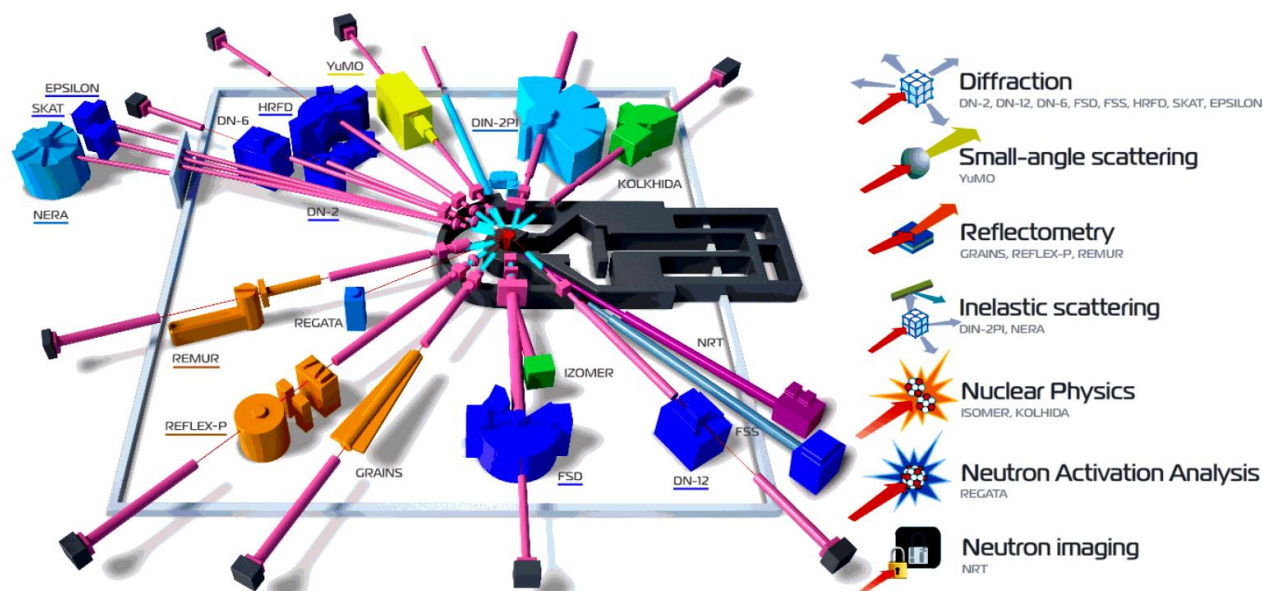

1.2 Irradiation facility

The irradiation facility is installed in the channel No. 3 zone and it is the modified version of the set-up previously created and used at that place [3].

The inner concrete wall in the direction of the 3d channel has an opening of the rectangular cross-section with 200 mm x 400 mm dimensions for extraction of neutron beam. The second (external) wall of the biological shield in the channel № 3 zone has a hole with 800 mm diameter for entering the irradiation facility to the circled corridor. The irradiation facility is intended for studying of a radiation hardness of any materials. The samples for irradiation may be placed not closer than 40 mm of the water moderator surface, behind which the IBR-2 reactor core is. The final distance from the sample under irradiation and the water moderator is selected according to the needed value of neutron integral fluence [3].

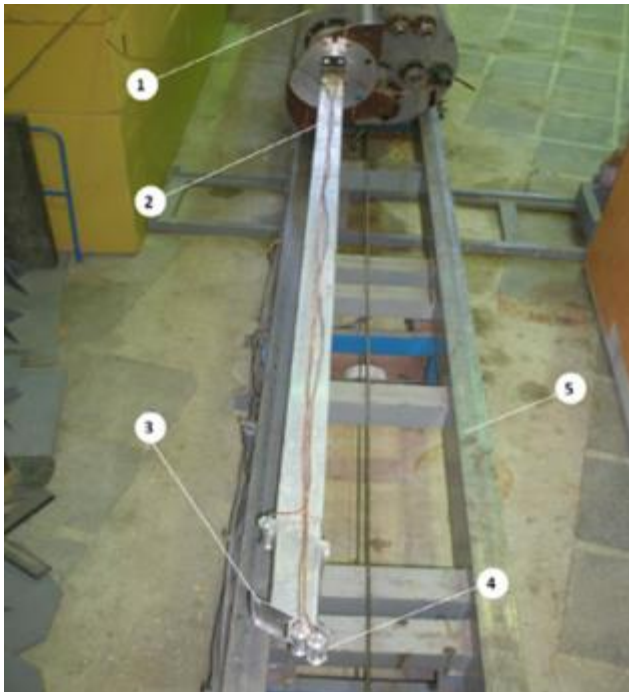

Fig. 4. The irradiation facility at the channel No. 3 of IBR-2 reactor experimental hall, the view from the external biological shield side:

1 – massive part of the irradiation facility,
2 – transport beam, 3 – metallic container for samples fastening, 4 – samples, 5 – rail way.

mm and length – 2.7 m. The transport beam is connected to the massive part of the irradiation facility (6) by folding flanged joint. The irradiation facility may be moved along the railway with the help of mechanism with electric drive [3].

The irradiation facility represents horizontally positioned 800 mm diameter steel cylinder filled with water (Fig. 4). The transport beam (2) is fixed to the front end of the cylinder (6). The samples to be irradiated are placed on the metallic container (3) made from Al alloy AMG6 with the transverse dimensions 160 mm x 160 mm. This alloy contains minimum quantity of admixtures, and its induced gamma activity quickly drops off after irradiation. The container is fixed to the front end of the transport beam, which is made from AMG6 alloy and H-shaped in cross-section with the following dimensions: width – 100 mm, height – 82

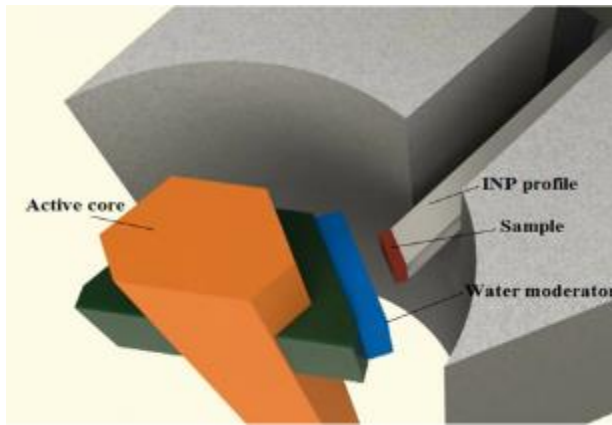

Fig. 5. Irradiation facility at IBR-2.

The movement of this facility along the rails are restricted (Fig. 4) both by terminal switches and emergency stops, positioned on both ends of the railway, and by the seen externally mechanical stop, which defines the minimal distance from the samples to the surface of the IBR-2 water moderator. The irradiation facility has a biological shield (Fig. 5) which prevents the

experimentalists from the ionizing irradiation during an operation of the reactor (Bulavin M. et al, 2015). An irradiation time depends of the neutron fluence required and is varied from the few hours up to 11 days – the normal duration of an operation cycle of the IBR-2 reactor. The samples temperature during irradiation does not exceed 50°C, that partially guaranteed by the extracting ventilation system. In case of necessity, irradiation of samples may be provided at cryogenic temperature. The control of neutron fluence is done (with an accuracy of about 5–10%) by placing activation foils near the irradiated materials with subsequent measurement of the foils induced activity. In the steel cylinder of the irradiation facility bended tubes were introduced. That permits to lay the power and signal cables to and from devices, which should be monitored during an assigned doze accumulation. More detailed picture of the forward part of the irradiation facility is shown at the Fig. 3. The samples under investigation would not exceed the size of the metallic container (160 mm 160 mm) [3].

2. PROPERTIES OF NEUTRONS.

2.1 History of neutron scattering.

In 1935 Professor James Chadwick was awarded the Nobel Prize in Physics for the discovery of the neutron. In 1942 Enrico Fermi showed that neutrons from fission of the uranium nucleus could support a controlled chain reaction. Earlier in 1938 he won the Nobel Prize in Physics for the discovery that slowed-down neutrons more readily interact with matter and could be used to detect the positions and motions of atoms. At the end of the Second World War the researchers in the USA gained access to the large neutron fluxes delivered by first nuclear reactors. The first neutron diffraction experiments were carried out in 1945 by Ernest Wollan at the Graphite Reactor in the Oak Ridge National Laboratory, USA. Together with Clifford Shull they established the basic principles of this experimental technique and successfully applied it to study different materials. Cliff Shull and Bertram Brockhouse

demonstrated that the directions in which neutrons are “elastically” scattered without changing energy provide information on the position and arrangement of atoms. In 1994 Shull and Brockhouse received the Nobel Prize in Physics for their pioneering ideas and contributions to the development of neutron scattering techniques.

Over the past fifty years a constantly increasing number of scientists from the fields of physics, chemistry, biology, materials science, geology and others have been turning to neutron scattering methods to find the answers to the most complicated problems in their fields of research [6].

2.2 Neutron sources.

At present, neutron scattering techniques have practically ceased to be used solely for investigating the atomic and magnetic structure and the dynamics of simple crystals. The emphasis has been increasingly placed on the studies of nanostructures, disordered systems, complex chemical reactions and catalytic processes. The research activities have extended into the areas of study of complex liquids, self-organizing systems and exotic electronic states as well.

All these problems can be solved only with the use of modern high-flux neutron sources: nuclear reactors utilizing controlled fission chain reaction of uranium or plutonium nuclei or proton accelerator-based spallation sources producing neutrons by bombarding heavy nuclei with high-energy protons. Neutron fluxes may be either continuous or pulsed. In such processes the produced neutrons have very high energies, which requires additional installation of neutron moderators on a source. As a result, moderated neutrons have wavelengths that are comparable to the atomic spacing in solids and liquids, and kinetic energies that are comparable to those of dynamic processes in materials. As a rule, moderators are made from aluminum and filled with liquid hydrogen or liquid methane (depending on the required parameters of a neutron beam).

High flux neutron sources are very expensive to build and to operate and therefore are few in number in the world. In 1950 the first research reactor intended specifically for scientific investigations was constructed. Its prime objective was to produce as high neutron flux as possible. Over the year's neutron sources have evolved into multi-purpose research facilities applied in a broad spectrum of experimental investigations. At present, hardly more than 30 laboratories in the world are equipped with medium- and high-flux neutron facilities. Research neutron sources serve only as sources of neutrons and are inapplicable for other purposes[6].

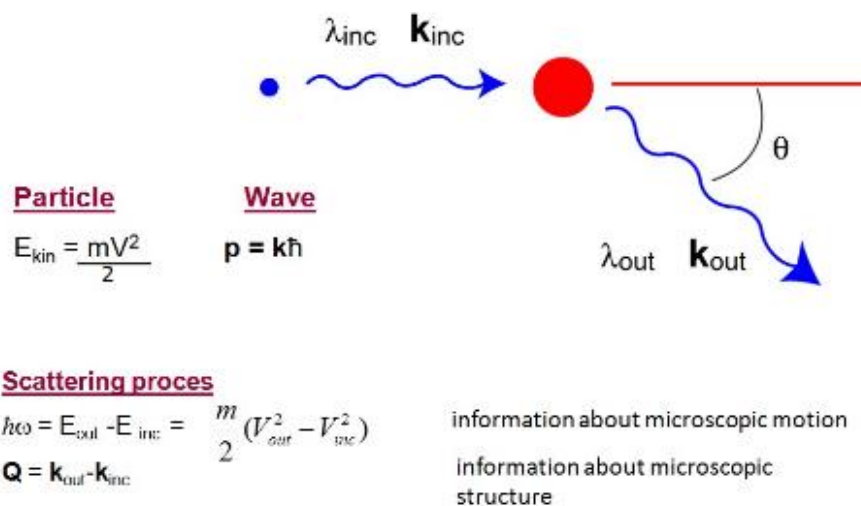

Fig. 6. Principles of neutron scattering

2.3 Properties of neutrons.

A neutron is an electrically neutral elementary subatomic particle with mass almost 2000 times that of the electron. The neutron lifetime as a free particle is about 15 min in spite of the fact that neutrons are stable when bound in an atomic nucleus.

Basic neutron properties used in neutron scattering: The energy of moderated neutrons is comparable to the energy of atomic and molecular motions and lies within the MeV to eV energy range.

The moderated neutron wavelength is comparable to interatomic distances, thus making it possible to study structures in the range from 10⁻⁵ to 10⁵ Å. Since neutrons are neutral particles, they interact with the nucleus of an atom rather than with the diffuse electron cloud. The neutron scattering cross sections from nuclei of neighboring elements in the periodic table may be substantially different, which makes it possible to “see” light nuclei in the presence of heavy ones, to effectively apply isotopic substitution technique and to easily distinguish the neighboring elements. This peculiarity is a great advantage over the X-ray scattering technique, since x-rays are scattered by the electron cloud. Neutrons have a magnetic moment and therefore can be used to study microscopic magnetic structure and magnetic fluctuations, which determine macroscopic parameters of matter.

Neutron radiation penetrates deep into materials, thus making it possible to study microscopic properties of bulk samples. Such investigations cannot be performed by means of optical methods, X-ray scattering or electron microscopy. Neutron radiation is completely non-destructive therefore neutrons can be used to study even delicate biological systems.

The main difference between neutron radiation and x-rays is that neutrons are scattered by the atomic nuclei. Consequently, there is no need for an atomic form factor to describe the

shape of the electron cloud of the atom and the scattering power of an atom does not decrease with the scattering angle as it does for X-rays. Diffraction patterns in the neutron scattering show well-defined diffraction peaks even at high scattering angles [15].

It might be well to point out one more important peculiarity of neutron radiation. X-ray scattering is practically insensitive to the presence of hydrogen in a structure, whereas the nuclei of hydrogen and deuterium are strong scatterers for neutrons. This means that using neutrons we can determine the position of hydrogen in a crystal structure and its thermal motions far more precisely. What's more, the neutron scattering lengths of hydrogen and deuterium have opposite signs, which makes it possible to apply "contrast variation" technique. By changing the isotopic composition of sample buffer (by varying the amount of hydrogen and deuterium), the experimenter can change the contribution of various components of the studied object into the scattering. In practice, nevertheless, it is not desirable to work with high concentrations of hydrogen in a sample, since neutron scattering by hydrogen has large inelastic component. This results in a large background, which only weakly depends on the scattering angle, and consequently the elastic scattering peaks are drowned in the inelastic background. This problem arises and becomes particularly pronounced when water-based liquid samples are studied. The variation of other isotopes apart from hydrogen and deuterium is possible but, as a rule, very expensive. Hydrogen is relatively inexpensive and at the same time particularly interesting because it plays an exceptionally large part in biochemical structures.

2.4 Neutron Guides and Mirrors

After producing free neutrons, which gain a lifetime around 15 minutes, the researchers have to focus them on their tiny samples in the experiment. But how to guide these little particles? The solution comes from quantum mechanics in combination with optics. As every particle, neutrons behave like particle waves. Therefore, they follow in principle the same laws as light waves. That also means they underlie the total internal reflexion (that is the same reason why glass fiber cables guide light waves). The crucial parameters in this equation are the medium in which the neutrons are travelling (in this case vacuum), the mirror material to reflect the neutrons and the angle between neutron direction and mirror surface (or more precise: the angle between direction and axis of incidence) [7].

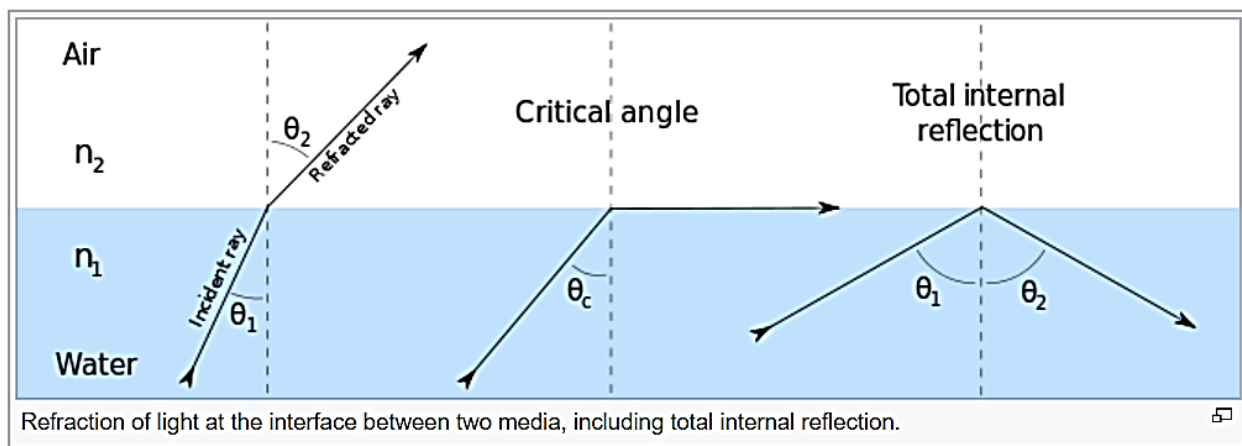

To construct a neutron mirror or neutron guide the first question to solve is to find a medium for neutrons, which is optically "thinner" than vacuum. That means, neutrons should travel faster in this medium than in vacuum. Scientists found out that a multi-layer system containing layers with alternating scattering characteristics (scattering length) and decreasing thickness fulfills this condition.

Nowadays one can produce neutron mirrors made of several hundred double layers of nickel-titan. The limiting angle for total reflection of a neutron mirror is much smaller than for light in the optical glass fiber; it also depends on the neutron wavelengths. A rough formula for the limiting angle for neutrons is 1° times the wavelength of neutrons in nanometer, which results for the wavelength of 0.5 nm to approximately 0.5° . This small angular range for the total reflection reduces the efficiency in comparison to an optical glass fiber, but it still allows transporting neutrons to a distance up to 10 - 50 meter.

The transmission of neutrons is improved by using so-called super-mirrors, with limiting angles larger by factors 2 - 3 as compared to normal neutron mirrors. Super-mirrors are using for example layer systems with alternating layers of pure isotopes ^{58}Ni and ^{62}Ni , which differ even more in their neutron scattering properties (scattering length). As such layer systems are rather expensive (material costs) there are limits of possible applications to just a few cases [8].

Neutrons as particle waves follow the same law for the total reflection as light waves. Neutrons can move freely in vacuum. To construct a neutron mirror or neutron guide the first question to solve was to find a medium for neutrons, which is optically "thinner" than vacuum. Scientists found such a medium, which is a multi-layer system containing layers with alternating scattering characteristics (scattering length) and decreasing thickness.

Nowadays one can produce neutron mirrors made of several hundred double layers of nickel-titan. The limiting angle for total reflection of a neutron mirror is much smaller than for light in the optical glass fiber; it also depends on the neutron wavelengths. A rough

formula for the limiting angle for neutrons is 1° times the wavelength of neutrons in nanometer, which results for the wavelength of 0.5 nm to approximately 0.5° . This small angular range for the total reflection reduces the efficiency in comparison to an optical glass fiber, but it still allows transporting neutrons to a remarkable distance up to 10 - 50 meter [7].

The transmission of neutrons is improved by using so-called super-mirrors, with limiting angles larger by factors 2 - 3 as compared to normal neutron mirrors. Super-mirrors are using for example layer systems with alternating layers of pure isotopes ^{58}Ni and ^{62}Ni , which differ even more in their neutron scattering properties (scattering length). As such layer systems are rather expensive (material costs) there are limits of possible applications to just a few cases.

3. EXPERIMENT

3.1 Experimental methods and techniques

The purpose of the irradiation device

The irradiation device (see Appendix 1) is designed to conduct research in the field of radiation materials with samples up to 800 cm². The sample irradiation zone is located in the annular corridor at a distance of at least 40 mm from the surface of the water moderator (B3-303) at beam No.3 of the experimental hall No.2 of the IBR-2 (Fig. 7).

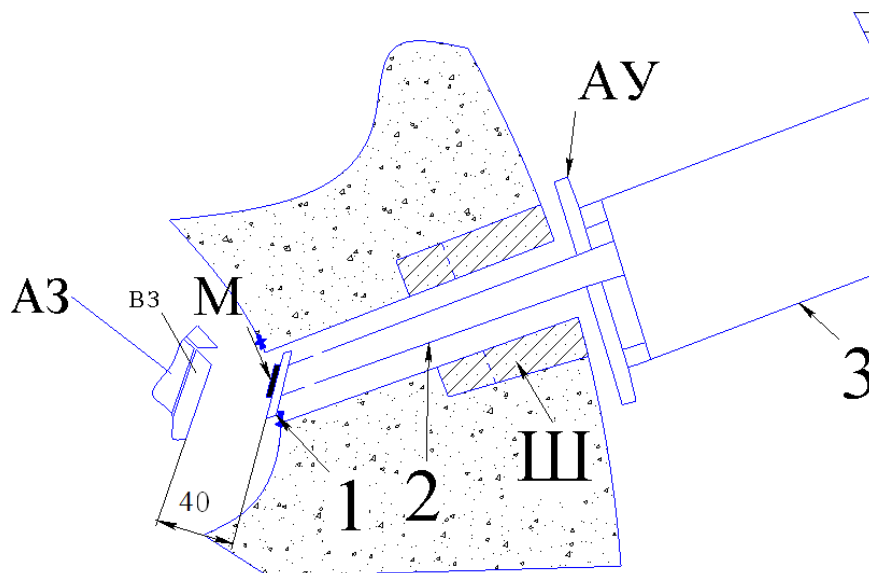

Fig. 7. Scheme of the location of samples near the IBR-2 core:

1-metal container for samples of the irradiation device; 2-transport I-beam of the irradiation device; M-samples for irradiation; A3-core of IBR-2; B3-water moderator B3-303; III-a gate of biological protection; AY-emergency stops; 3 - head of the irradiation device.

Description of samples

The following materials and components are used as samples:

- 1) Materials of detectors with a length of 50 mm and a diameter of 8 mm in an aluminum cover, which can be connected by electrical cables to a computer located in the experimental house.
- 2) Transparent silicon detectors in a brass package.
- 3) Aromatic hydrocarbons - mesitylene, xylene, naphthalene, triphenylmethane, polyethylene in the solid and liquid state, located in aluminum capsules.
- 4) Samples for neutron activation analysis (indium, tin, gold, nickel chromium).
- 5) Historical and geological objects, including topaz, beryl, etc.

Irradiation of fissile materials by this instruction is not provided.

Description of the irradiation device

The irradiation device (4) is a steel cylinder 800 mm in diameter, filled with water (head part (3), see Appendix 1 and lines 4000.00.00 Sb.), With a transport I-beam fixed to it (2). Samples for irradiation are placed in a metal container (see the drawing 2012.00.00.03), made of AMG6 alloy, dimensions 160mm x 160mm x 10mm, which is fastened to the end of the transport I-bar (see drawing 2012.00.00 SB), 100 mm wide, height 82 mm and length 2.7 m, also made of AMG6 alloy. The section of the transport I-beam is connected to the irradiation device by means of a collapsible flange connection. Moving the irradiation device along the rail track is carried out by means of an electric drive mechanism. The movement mechanism is controlled by the remote control (15). The movement of the plant is limited by limit switches, emergency stops (AY) located at both ends of the track and an apparent mechanical stop (in appendix 1 - BMY), which regulates the distance from the samples to the surface of the IBR-2 water moderator from the side of the 3 channels. The irradiation device has biological protection (in appendix 1 - 5,6,8), which protects the personnel from ionizing radiation during operation.

Irradiation of samples

After raising the reactor power, proceed with the implementation of a specific program of work on irradiation during the whole reactor cycle without replacing the samples.

Moving the device after the experiment is completed

1. Moving the installation into the annular corridor

The installation is moved to the annular corridor only after the reactor power is reduced to "zero" and the controls and protection are withdrawn before the lower limit switches operate.

- a) by the request of the responsible experimenter, the shift supervisor of the IBR-2 removes the blockage of the movement of the device and authorizes its movement, b) by moving the unit away from the moderator surface,
- c) turn on the electric drive of the irradiation unit and continue the movement of the device from the apparatus body,
- d) after confirmation by the shift supervisor in the presence on the control panel of the reactor of the signal "Installation - in the annular corridor", turn off the electric drive of the irradiation unit.
- e) after removal of the lock to move the gate, the shift supervisor instructs the electrician on duty to power on unit gate No. 3 and closes it.

2. Moving the device to the experimental hall

- a) prepare lead protection (9) in the experimental room,
- b) after receiving permission of the shift supervisor (closing the gate # 3) to start moving the device from the circular corridor to the experimental hall,
- c) after the device has been moved to the experimental room, a lead shield must be installed on the rail track into which head part of the device must be entered, while the concrete door (8) must be closed,
- d) open the concrete door, roll the irradiation unit 5 m away from the biological protection of the experimental room No. 2 of the IBR-2,
- e) insert the rollback protection (10) in the biological protection of the experimental room No. 2 of the IBR-2 and move the irradiation unit with lead protection as close as possible to the rollback protection (10), and close the concrete door (8).

3.2 Neutron energy spectrum and flux densities in channel No. 3

Neutron energy spectrum and flux densities were measured by method of the neutron activation analysis (NAA). Threshold detectors were positioned on the transport beam at 300 mm, 500 mm and 3150 mm distances off the outer surface of the neutron moderator. The measurements of the induced activity of the threshold detectors are giving possibility to get differential energy density of the neutron flux (DEDF) for the energy ranges $E > 1 \text{ MeV}$ and $E < 0.1 \text{ MeV}$. Reconstruction of the neutron flux for the energy range 0.1 1 MeV by the NAA method appeared to be impossible due to the absence of suitable threshold indicators for this energy range [3].

Processing of the experimental data has shown that neutron DEDF in the energy range $E > 1 \text{ MeV}$ is well described by the function

$$\Phi(E) = \left(C_1 \cdot e^{-0.693E} + C_2 \cdot \frac{e^{-\alpha E}}{E} \right) \cdot 10^{12} \frac{n}{\text{cm}^2 \cdot \text{s} \cdot \text{MeV}}$$

where $\alpha \approx 1$, and coefficients C_i (suggested in the Table No. 1) depend on the distance X between the samples and the reactor moderator surface only.

In the resonance energy range $E < 0.1$ MeV DEDF of neutrons is described by power-mode function

$$\Phi(E) = C_x E^{-\beta_x}$$

where $\beta_x = 0.88$, and coefficient $C_x \approx C_2$ (Table 1) with the error about 2%.

For the practical calculations of neutrons DEDF in channel No. 3 of IBR-2 reactor from 0.5 eV to 14 MeV energy range one can use function (3). It fills up the energy interval 0.1–1 MeV not covered by NAA and smoothly converges to the function of resonance neutrons flux from the left and to the function of fast neutron flux for $E > 1$ MeV from the right (Fig. 3):

$$\Phi(E) = \left(C_1 \cdot e^{-0.693E} + C_2 \cdot \frac{e^{-0.97E}}{E^{0.88}} \right) \cdot 10^{12} \frac{n}{\text{cm}^2 \cdot \text{s} \cdot \text{MeV}}$$

where coefficients C_i preserve the values shown in Table 4.

Table 4. Coefficient values in formulae (1) for the different X at full power of reactor. The error of the coefficient values C_1 and C_2 does not exceed 8%.

X [m]	C_1	C_2
0.3	0.470	0.39
0.5	0.216	0.183
0.7	0.085	0.072

Actually, in the resonance range, with decreasing of neutron energy, both exponents in function (3) quickly tend to the unity, the ratio of the first term to the second one tends to zero, and function (3) arrives to the type (2). In the high energy interval $E > 3$ MeV, the second terms in the functions (1) and (3) are negligibly small as compared to the first item. Finally, functions (1) and (3) differ from each other by less than 2% in neutron energy interval $1 \text{ MeV} < E < 3 \text{ MeV}$ [3].

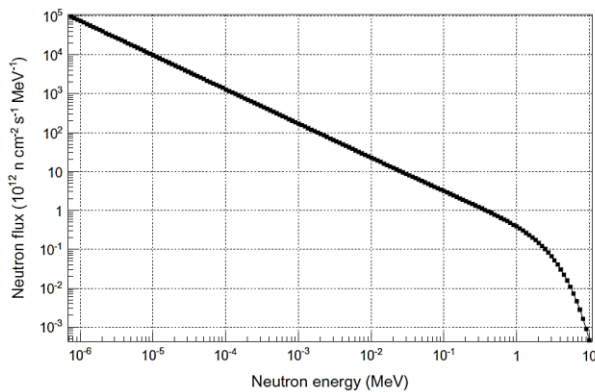

Fig. 8. DEDF of neutrons in channel No. 3 of IBR-2 reactor at distance 0.3 m of the reactor moderator (it is the result of the NAA restoration with the artificial fill gaps in the 0.1–1 MeV interval).

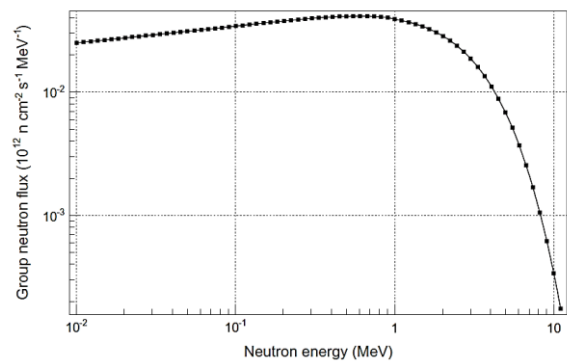

Fig. 9. Neutron group fluxes at 0.3 m distance from the reactor moderator. Each decade of the energy scale contains 23 groups, the group boundaries are equally distributed over logarithmic scale.

Fig. 9 shows the dependence of group fluxes on neutron energy (i.e. integral of DEDF over neutron energy intervals equally distributed over logarithmic energy scale). This value is convenient for quick estimation of the neutron flux density at any energy interval. The measured flux density of the thermal neutrons ($E < 0.25$ eV) at the 0.3 m distance from the moderator surface amounts to $(0.68 \pm 0.02) 10^{12} \text{ n}\cdot\text{cm}^{-2}\cdot\text{s}^{-1}$.

3.3 The space distribution of the neutron flux density

The neutron spectrum was also measured at 3.125 m distance from the reactor moderator surface – at the point where the transport beam was fixed to the irradiation facility butt end. For such distance the spectrum becomes much harder: for the energy greater than 5 MeV neutron flux near the butt end is 40 times lower than at 0.5 m off moderator, for the middle neutron energy 1–5 MeV flux decreases by a factor of 100, and a thermal neutron flux – by a factor of 170.

An induced activity of Ni samples, which were positioned at different distances along the transport beam, was measured. The neutron flux intensity distribution at distances between 0.5 m and 1 m of the reactor water moderator surface is described by an exponential law. An intensity decreases by half at a distance of 18 cm. In other words, flux gradient value is around 4% per 1 cm.

Small gradient of an order of 1–2% per 1 cm was observed in directions that are normal to the axis of channel No. 3. The neutron flux decreases from the left to right (when facing the reactor). This transverse gradient is due to the peculiarity of the reactor shield geometry (Fig. 1). One must take it into account when selecting samples positions and dimensions. For the large-scale samples, it is possible to decrease the gradients by introducing neutron reflectors but this approach requires prolonged preparation [3].

3.4 Neutron fluencies and absorbed doses during irradiation at IBR-2

On the base of the data of differential energy density of neutron flux in the channel No. 3 of the IBR-2 reactor presented above and, partly, calculated with 3D-neutron code, the following values of irradiation parameters, expected for 11 days (one cycle) of reactor operation, were estimated [3]:

- Maximal fluence of neutron with energy above 1 MeV when sample is installed at 40 mm apart from the moderator – $10^{18} \text{ n}\cdot\text{cm}^{-2}$, and for the distance 0.3 m – $4\cdot 10^{17} \text{ n}\cdot\text{cm}^{-2}$.
- Maximal absorbed dose in water for the same installation positions: at 40 mm – 100 MGy (10^8 J/kg), at 0.3 m – 40 MGy.

- Maximal KERMA in silicon at the 0.3 m distance –1 MGy; number of displacements per atom is equivalent to the action of $2 \cdot 10^{18} \text{ n} \cdot \text{cm}^{-2}$ fluence of 1 MeV energy neutron beam (so called “1 MeV neutron equivalent flux”).
- Minimal fluence of neutrons with energy above 1 MeV, when sample is installed at the most far displaced point, is equal to $10^{15} \text{ n} \cdot \text{cm}^{-2}$. Now, the facility is going to be modernized to permit irradiation of the objects up to 90 mm x 90 mm size by the small doses down to $10^{10} \text{ n} \cdot \text{cm}^{-2}$. It means that the range of available irradiation loads for the single irradiation facility will cover 8 orders of magnitude. It should be mentioned also, that an irradiation period less than 11 days must be agreed with authorities in advance. It is also planned to supply the facility with special transport system to allow for bringing the samples to the IBR-2 reactor moderator surface directly during operation of the reactor at nominal power.
- Absorbed dose rates of gammas: maximal 60 kSv/h (for fast neutron flux about $10^{12} \text{ n} \cdot \text{cm}^{-2} \cdot \text{s}^{-1}$), minimal (far from the reactor end of the transport beam) – less than 400 Sv/h. A ratio of the “neutron/gamma” doses may be modified, at least, one order of magnitude at any direction by applying filters corresponding to the task.

4. RESULTS AND CONSULITIONS

4.1 Results of neutron guide glasses irradiation

First results of neutron guide glasses irradiation

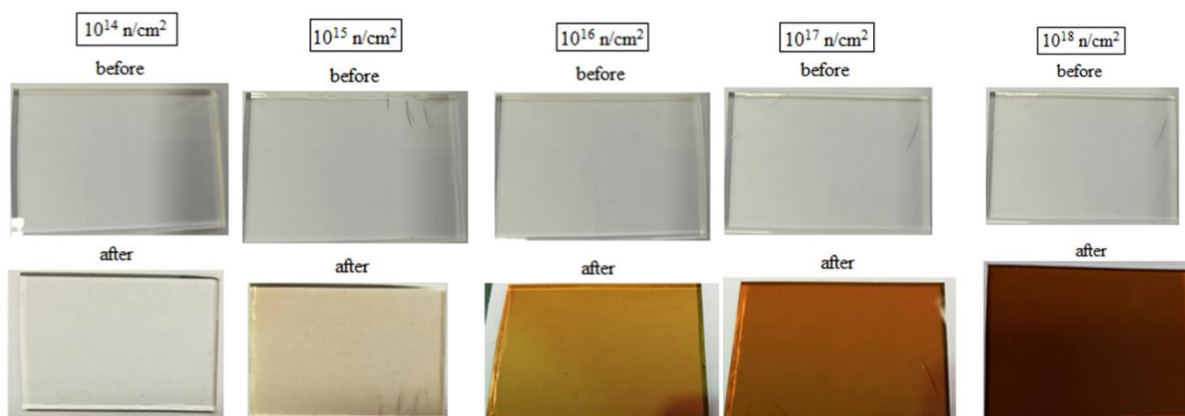

K208	SiO ₂	B ₂ O ₃	K ₂ O	NaCl	Al ₂ O ₃	CeO ₂
%	76,92	10,56	9,59	0,97	1,38	0,58

Experimental glass compounds are given in Table 5.

Table 5. Chemical compounds of glass

Compound No.	Oxide content, mass %														
	SiO ₂	B ₂ O ₃	K ₂ O	Na ₂ O	Al ₂ O ₃	CaO	MgO	ZnO	BaO	Fe ₂ O ₃	TiO ₂	over 100 %		Na ₂ O	CeO ₂
				NaCl								Bi ₂ O ₃	WO ₃		
K208	76,92	10,56	9,59	0,97	1,38										0,58

Notes on the elemental composition:

1) In the analysis of K208 glass, a peak of 145.5 keV was detected 3 months after irradiation, which corresponds to the Ce-141 isotope with a half-life of 33 days. It is formed from stable Ce-140 in thermal neutron capture reactions. In glasses, it is present as a CeO₂ oxide. Even 0.58% of it in K208 gives high activity at high doses. After 3 months, the activity of K208 glass irradiated with a 10¹⁸ n/cm² fluence decreased 8 times and amounts to 30 mSv/h (according to the law of radioactive decay). Expected by the end of the year, activity will decrease 72 times to 0.4 mSv/h, which is still a lot for the transfer of samples. After another 5 months, the activity will decrease 32 times, the activity of glass will be, i.e. 1 background, which can already be transferred to the customer. Samples irradiated at lower fluences (from 10¹⁵ n/cm² to 10¹⁷ n/cm²), respectively, can be transferred earlier.

2) As for the remaining glass types, in our opinion the main contribution to the activity will be given by zinc isotope Zn-65, with a half-life of 244 days. (the peak is 1115 keV). Even 2.5% of it in the oxide now gives a lot of activity, and taking into account the long half-life, all glass types irradiated with high doses cannot be returned at all. Considering the adding of SrO, one can say that after irradiation with the main isotope, there will be Sr-85 with a half-life of 64 days, this is significantly less than for Zn-65, however, 2 times more than Ce-140, respectively, the delivery dates will increase, in comparison with K208 glass.

4.2 Conclusions and suggestions

1. The irradiation facility at the channel No. 3 of the IBR-2 reactor permits to investigate the influence of irradiation on the material properties in the wide ranges of energy and flux values of neutrons and gammas.
2. During the reactor standard operation cycle of 11 days, it is possible to obtain the fluence of fast neutrons more than 10¹⁸ n·cm⁻² in 18 cm x 18 cm area. Neutron spectra were measured at different points of the irradiation zone, and the possibility to vary irradiation load within eight orders of magnitude was shown.
3. It is necessary to search materials for the replacement of CeO₂, ZnO and SrO so that on the one hand to not "damage" the experimental glass compound, to not damage their properties, and on the other hand obtain isotopes with a minimum half-life. Customer

should give a list of "suitable" oxides, which can be replaced with current ones, and we will try to predict possible activities and give recommendations which one is preferable to use.

5. ACKNOWLEDGEMENT

I would like to convey my gratefulness to my supervisor in this Summer Student Program, Maksim Viktorovich Bulavin, first of all for accepting me as a student. And also, for his patience, his support and the excellent guidance. The knowledge that I have gained throughout this eight week I perceive as highly valuable component in my future career development.

I would especially like to thank my supervisor in Uzbekistan, Kurbanov Bakhtiyar Ibragimovich, for encouraging me and supporting me to take part in the Program.

Also, I would like to thank the Joint Institute for Nuclear Research for giving me the opportunity to participate in the Summer Student Program and for financial support. Stay in Dubna was one of the best adventures in my life.

I am also grateful to INP AS RUz staff Zabardast Narzikulov, Salomjon Turdiev and the staff of the JINR FLNP Bekhzodjon Abdurakhimov for useful discussions.

Lastly, I also thank my family for always supporting me in all possible ways.

6. REFERENCES

1. Ananiev V., Vinogradov A., Dolgikh A., Pepelishev Yu. – Physical and power start-up of the modernized IBR-2M research reactor, European Nuclear Society Conference, 2013, pp 16-21;
2. Belushkin A. - IBR-2 – the fast-pulsed reactor at Dubna, Neutron News 2:2 14-18, 2006;
3. Bulavin M., Cheplakov A., Kukhtin V., Kulagin E., Kulikov S., Shabalin E., Verkhoglyadov A. - Irradiation facility at the IBR-2 reactor for investigation of material radiation hardness, Nuclear Instruments and Methods in Physics research B 343 26-29, 2015;
4. Frontasyeva M., Pavlov S. - Analytical Investigations at the IBR-2 Reactor in Dubna, VIII International Seminar on Interaction of Neutrons with Nuclei, 2000;
5. Shabalin E., Verkhoglyadov A., Bulavin M., Rogov A., Kulagin E., Kulikov S. - Spectrum and Density of Neutron Flux in the Irradiation Beam Line No. 3 of the IBR-2 Reactor, Physics of Particles and Nuclei Letters 12:2 336-343, 2015;
6. <http://flnph.jinr.ru/en/education/properties-of-neutrons>
7. https://www.helmholtz-berlin.de/mediathek/info/material/neutronen/neutronenleiter-spiegel_en.html
8. <https://hzbzlog.com/hzbneat/guide-chop-and-catch-me/Zk3h7RAAz->